

# Deepen Your Knowledge.



## **ZEISS Crossbeam Family**

Your FIB-SEM for High Throughput 3D Analysis and Sample Preparation

[zeiss.com/crossbeam](https://zeiss.com/crossbeam)



Seeing beyond

# Your FIB-SEM for High Throughput 3D Analysis and Sample Preparation

- › In Brief
- › The Advantages
- › The Applications
- › The System
- › Technology and Details
- › Service

**ZEISS Crossbeam combines the powerful imaging and analytical performance of a field emission scanning electron microscope (FE-SEM) column with the superior processing ability of a next-generation focused ion beam (FIB).**

Crossbeam gives your 3D work that dynamic edge, whether you are milling, imaging or performing 3D analytics. Extract true sample information from your SEM images using Gemini electron optics. The Ion-sculptor FIB column introduces an altogether new way of FIB-processing. By minimizing sample damage you'll maximize sample quality—and perform experiments faster at the same time.

Customize your instrument to achieve both high quality and high throughput in TEM lamella preparation. Exploit the variable pressure capabilities of Crossbeam 350. Or use Crossbeam 550 to prepare and characterize your most demanding samples, choosing the chamber size that best suits your samples.

You may be working on your own or in a multi-user facility, as an academic or in an industrial lab. If you've set your sights on high impact results, Crossbeam's modular platform concept lets you upgrade your system as your needs grow.



# Simpler. More Intelligent. More Integrated.

- › In Brief
- › **The Advantages**
- › The Applications
- › The System
- › Technology and Details
- › Service

## Maximize Sample Insights in Both 2D and 3D

Count on excellent images from any sample thanks to the Gemini electron optics of your ZEISS Crossbeam. You will achieve high resolution and contrast while reaping the benefits of high signal-to-noise ratios, right down to very low accelerating voltages. Prepare high quality samples, like TEM lamellae, using the FIB's low voltage performance and characterize your samples comprehensively in 3D. Use a wide choice of detectors, including the unique InLens EsB (energy selective backscatter) detector for pure material contrast. Investigate non-conductive specimens undisturbed by charging artifacts, offset either with local charge compensation while keeping high vacuum in the chamber or with variable pressure available in Crossbeam 350.

## Increase Your Sample Throughput

Combine Gemini optics with a new way of FIB machining: the superior low voltage performance of the Ion-sculptor FIB column delivers fast and precise results while keeping amorphization damage on your sample to a minimum. Use these advantages especially for the preparation of TEM lamellae – even challenging samples. Benefit further from the FIB's high current capability that saves time and achieves excellent FIB profiles with up to 100 nA current—without compromising the ultimate FIB resolution. Save even more time with automatically prepared batches of cross-sections or with any user-defined pattern. And the benefits just keep on coming throughout your long-term experiments as optimized routines enhance FIB source life-time and stability.

## Experience Best 3D Resolution

Enjoy precise and reliable results in FIB-SEM tomography with best 3D resolution and leading isotropic voxel size. The InLens EsB detector lets you probe and image less than 3 nm in depth. Expand the capacity of your Crossbeam with Atlas 5, our market-leading package for fast, precise tomography. You will save time by collecting your serial section images while milling. You also have the advantage of trackable voxel sizes and automated routines for active control of image quality. Meanwhile, Atlas 5's new integrated Analytics module enables 3D EDS and 3D EBSD analysis during tomography runs.



Count on excellent images thanks to Gemini electron optics.



Benefit from the superior low voltage performance of the Ion-sculptor FIB-column, especially for TEM lamella preparation.



3D tomogram of a solid oxide fuel cell anode made of the heat resistant composite material Nickel Samaria-doped ceria.

# Your Insight into the Technology Behind It

- › In Brief
- › **The Advantages**
- › The Applications
- › The System
- › Technology and Details
- › Service

## Profit from Gemini Optics

Crossbeam's FE-SEM column is based on Gemini electron optics. You will appreciate the long-term stability of your SEM alignment and the effortless way it adjusts all system parameters such as probe current and acceleration voltage. Unlike other FE-SEMs, Gemini optics don't expose your specimen to a magnetic field. This allows you to achieve distortion-free, high resolution imaging over large fields of view as well as to tilt the specimen without influencing the electron optical performance. Even magnetic samples can be imaged easily.

## Choose between Two Columns:

- The Gemini VP column of Crossbeam 350 gives you maximum sample flexibility and multi-purpose environments. With the optional Variable Pressure (VP) you can perform *in situ* experiments under excellent analytical conditions, even with outgassing or charging samples.
- The Gemini II column of Crossbeam 550 has a double condenser system that enables high resolution, even at low voltage and high current. It's ideal for high resolution imaging at high beam current and for fast analytics
- Simultaneous Inlens SE and Inlens EsB imaging provides unique topographical and material information in less time.

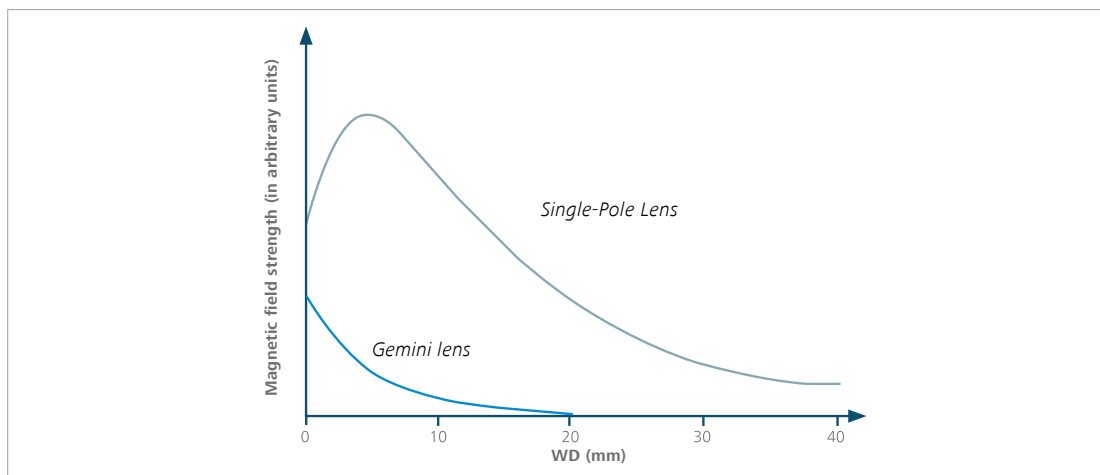

Magnetic field leakage of the Gemini lens compared to a traditional single-pole lens design. The minimum magnetic field on the sample allows highest ion and electron beam performance on a tilted sample as well as high resolution imaging of magnetic materials.

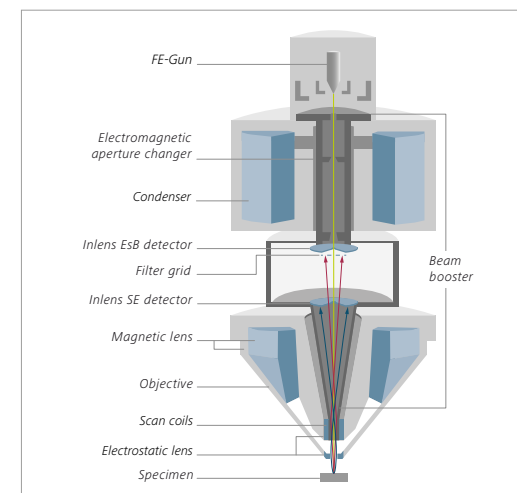

ZEISS Crossbeam 350: Gemini column with single condenser, two Inlens detectors and VP capability.

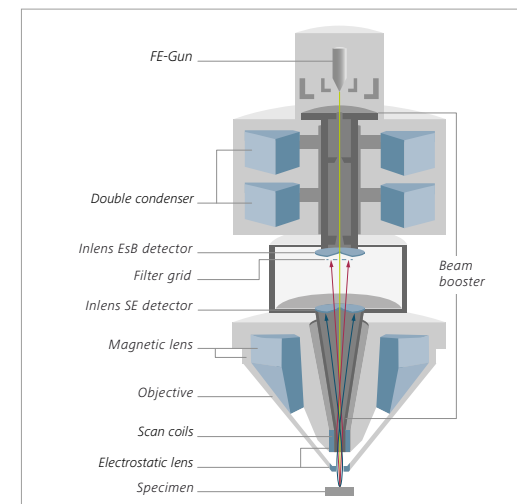

ZEISS Crossbeam 550: Gemini II column with double condenser and two Inlens detectors.

# Your Insight into the Technology Behind It

- › In Brief
- › **The Advantages**
- › The Applications
- › The System
- › Technology and Details
- › Service

## Discover a New Way of FIB-Machining – From Massive Ablation to Nanometer Precision

Maximize sample quality by using the low voltage capabilities of the Ion-sculptor FIB column. Minimizing amorphization of delicate specimens will give you the best results after thinning or polishing—with the added advantage of fast probe current exchanges to accelerate your FIB applications. Or opt for high current performance and double the speed of your 3D FIB-SEM applications by working with the high gallium ion beam currents. You'll get precise and reproducible results with maximum stability during the acquisition time. The column design gives you access to five orders of magnitude in beam current, from 1 pA up to 100 nA. The larger beam currents of up to 100 nA allow fast and precise material removal and milling processes. Meanwhile, at low currents you will achieve exceptionally high FIB resolution of less than 3 nm. The gallium focused ion beam source – the so-called LMIS (liquid metal ion source) Ga source—is designed for a typical lifetime larger than 3000  $\mu\text{Ah}$  when operating at a target emission current of 2  $\mu\text{A}$ . For long-term experiments, you have the bonus of the Crossbeam family's automatic FIB emission recovery.

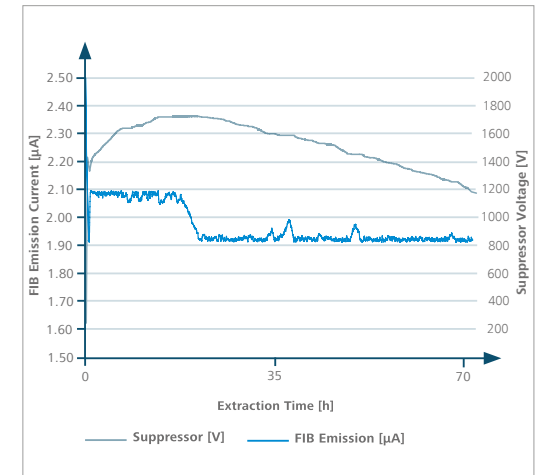

Regulation characteristic of Ga source emission current. The suppressor voltage regulates the total emission current between 1.9  $\mu\text{A}$  and 2.1  $\mu\text{A}$ .

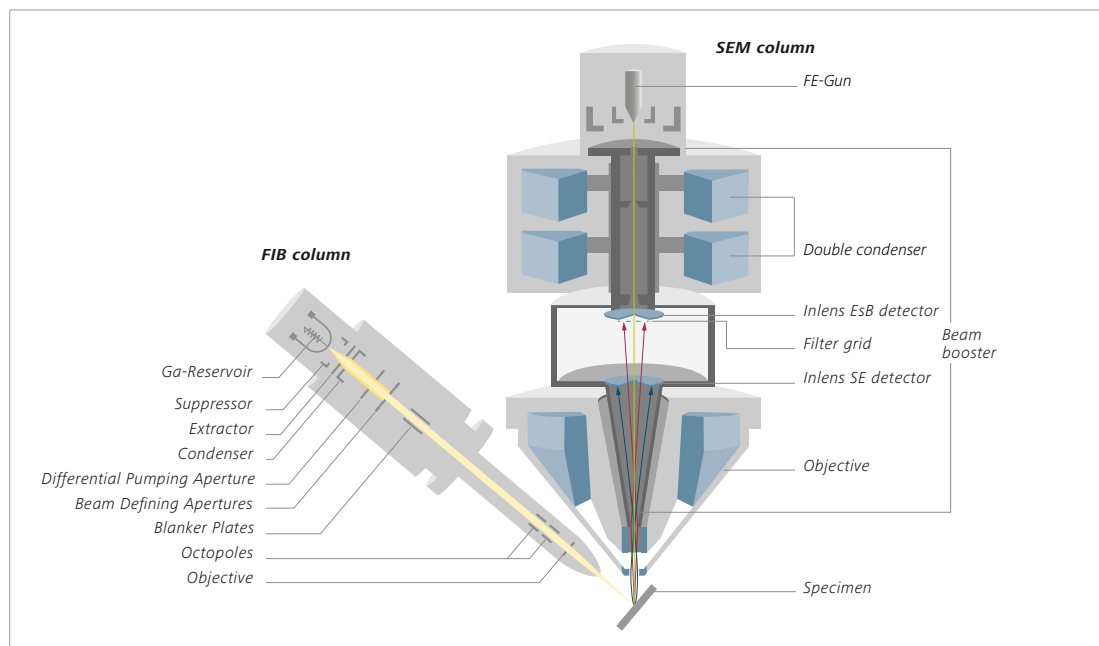

ZEISS Crossbeam 550: FIB- and FE-SEM column arranged at an inclination angle of 54°.

# Expand Your Possibilities

- › In Brief
- › **The Advantages**
- › The Applications
- › The System
- › Technology and Details
- › Service

## Customize Your Crossbeam with the Remote Application Programming Interface

Innovative experiments will often require new functionality beyond what is provided by the operating software of your electron microscope. That's why the open programming interface of Crossbeam is designed to allow access to almost every microscope parameter. The remote API lets you take complete control of electron and ion optics, stage, vacuum system, detectors, scanning and image acquisition from custom programs – whether running on the system PC or on a remote workstation.

ZEISS provides both documentation and code examples in various programming languages – plus technical support to make sure you get the results you want. Quickly.

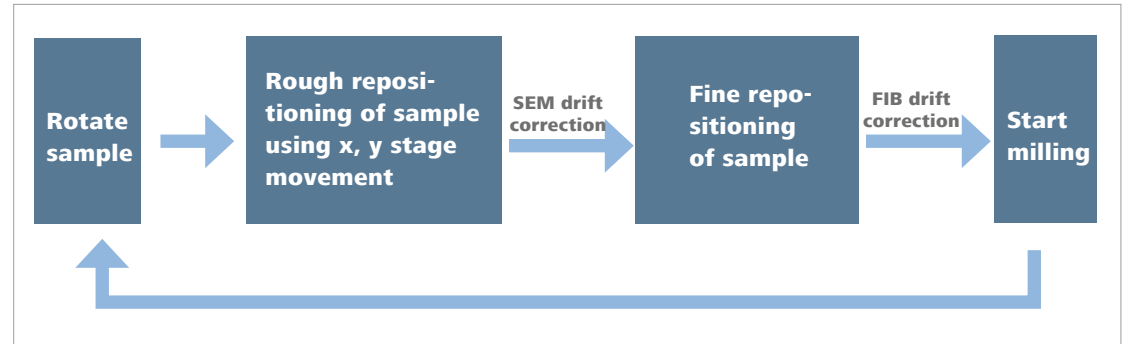

Workflow for lathe milling, implemented in the custom application SmartLathe and using the API interface.

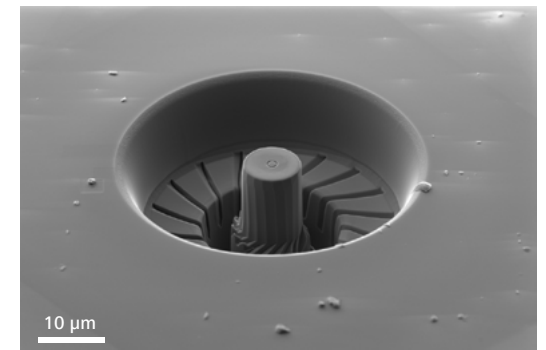
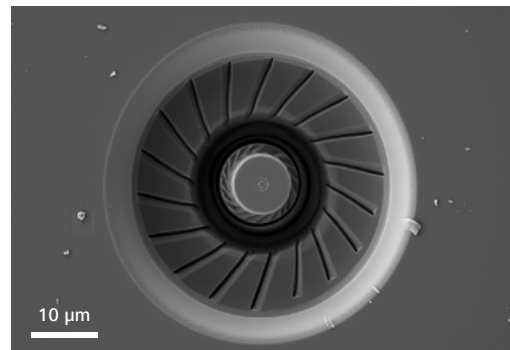

Pillar for compression testing after being machined using lathe milling: SEM top view (left), SEM side view (right).

# Expand Your Possibilities

- › In Brief
- › **The Advantages**
- › The Applications
- › The System
- › Technology and Details
- › Service

## How a Laser FIB Workflow Enhances Your *in situ* Studies

For *in situ* studies you need to localize ROIs in 3D, ablate material via a targeted preparation and do 3D imaging and analytics. Add a femtosecond laser to your ZEISS Crossbeam and benefit from ultra-fast sample preparation.

- Gain rapid access to deeply buried structures
- Prepare extremely large cross-sections up to millimeters in width and depth
- Benefit from minimal damage and heat affected zones due to ultrashort laser pulses
- Perform laser work in a dedicated chamber to avoid contamination of the main instrument
- Find your hidden ROIs by correlation with previously acquired X-ray microscopy datasets



Crossbeam 350 laser. The femtosecond laser is mounted onto the airlock, thus avoiding chamber contamination during laser machining.

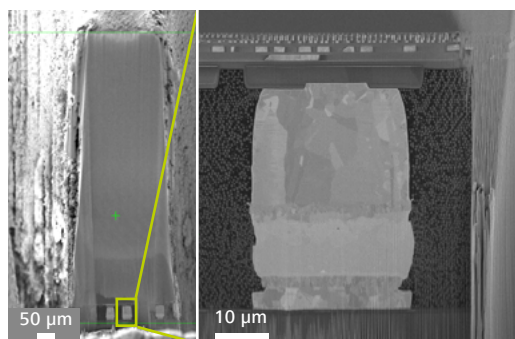

Deep laser cut in electronics sample to gain access to buried ROI in 860 µm depth (left). The targeted structures were already visible after laser preparation. Minimal time was needed to FIB polish only the ROI area (right) and reveal finest details of the microbump.

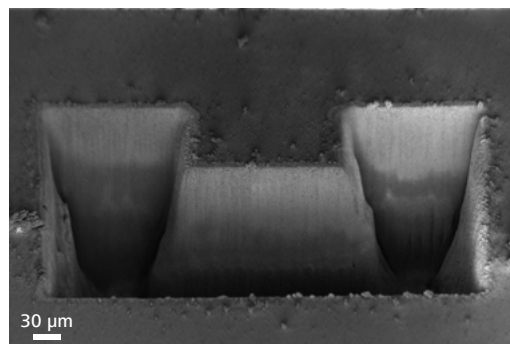

200 µm wide cross section in a ceramic sample with 200 µm clearance on each side cut by fs-laser in less than 30 s. This pattern can be used to investigate the micro-structure of the sample material in cross section or as pre-preparation for a subsequent FIB-SEM tomography run.

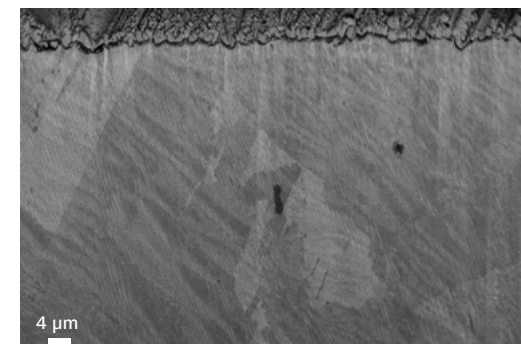

Surface detail of a cross section (similar to that shown on the left) in a metal alloy sample depicting the quality of the cut after polishing only with the laser. No FIB polish was applied. The grain structure as well as inclusions are directly visible on a large area.

# Expand Your Possibilities

- › In Brief
- › **The Advantages**
- › The Applications
- › The System
- › Technology and Details
- › Service

## It's Easy to Create TEM Lamellae

Simply use Automatic Sample Preparation (ASP) for your TEM sample: it includes all necessary steps and it's ready for lift out.

### How it Works

- Click on the TEM sample icon.
- Draw a line to define the location of the lamella on your sample.
- Trigger execution.

## Prepare Batches of TEM Lamellae – Automatically

- Execute a batch of TEM samples at predefined sites without supervision.

### How it Works

- Define location of single TEM lamella and transfer to process list.
- Repeat step 1 as often as required or perform copy & paste in sample mode.
- Execute process list.



▶ [Click here to view this video](#)

*X<sup>2</sup> sample holder. Use the patented X<sup>2</sup>-preparation method to prepare ultra-thin, stable TEM lamellae and obtain a homogeneous thickness of less than 10 nm without causing sample damage.*

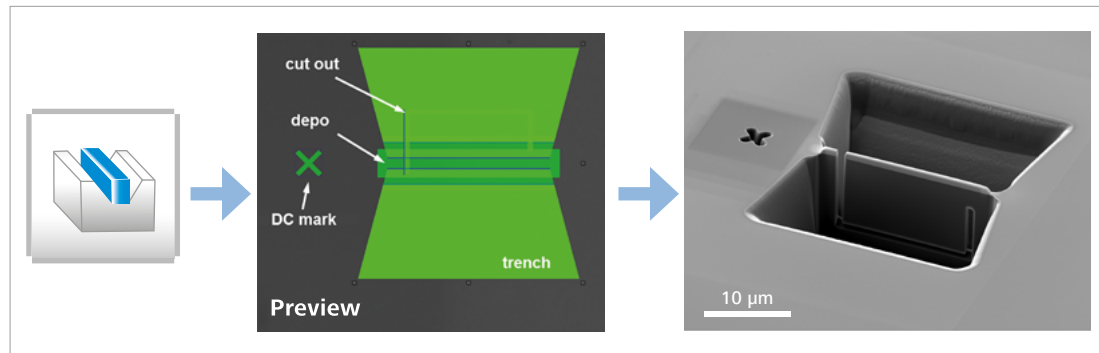

*Illustration of the simple three-step workflow for TEM sample preparation (depo stands for deposition, DC for drift correction)*

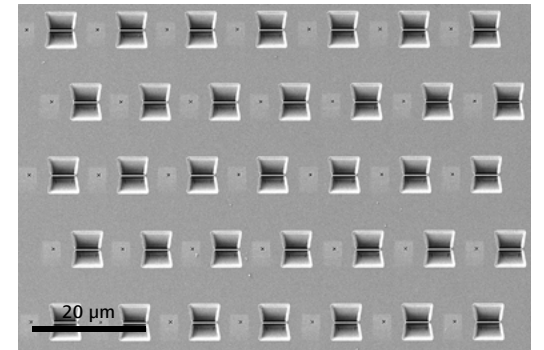

*Array of TEM lamellae prepared automatically.*



# Expand Your Possibilities

- › In Brief
- › **The Advantages**
- › The Applications
- › The System
- › Technology and Details
- › Service

## Select Your Micromanipulator for TEM Lamella Lift-out

When starting a TEM lamella preparation workflow find your region of interest quickly with the help of the super-eucentric 6-axis stage and always stay at eucentricity when tilting the sample no matter which working distance. Prepare your sample and eventually utilize a micromanipulator for the next steps in the workflow.

It's quick and easy to lift out a prepared TEM lamella from the bulk. Select a micromanipulator that is targeted to your needs in flexibility, freedom of operation and ease-of-use in control. Attach your lamella to a grid for final thinning and low kV polishing.

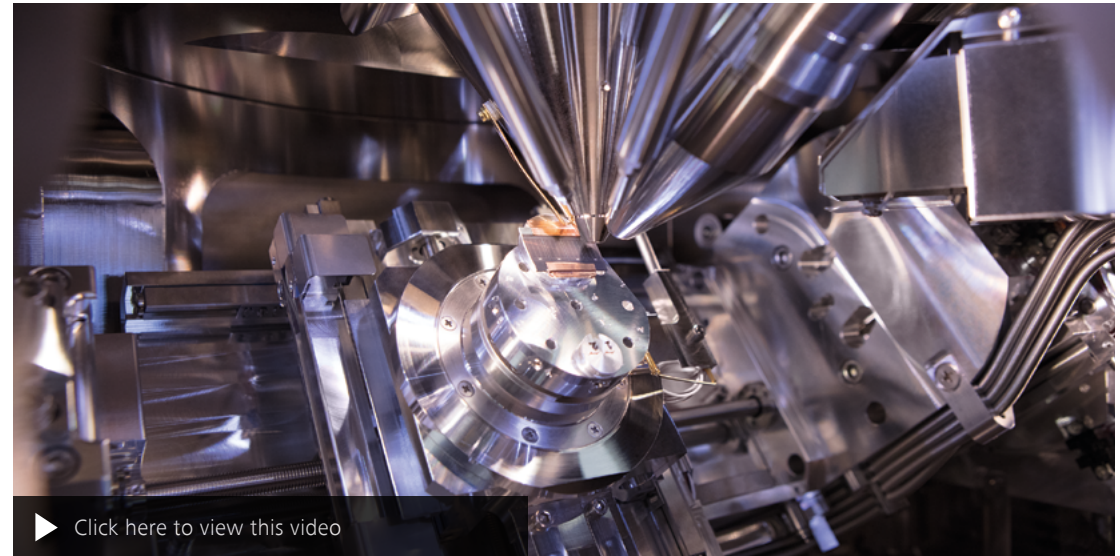

▶ [Click here to view this video](#)

*Find your region of interest quickly with the help of the super-eucentric 6-axis stage and always stay at eucentricity when tilting the sample. Prepare your sample. Lift out your TEM lamella, eventually.*



*The micromanipulator of your choice will be configured to enable optimized workflows.*

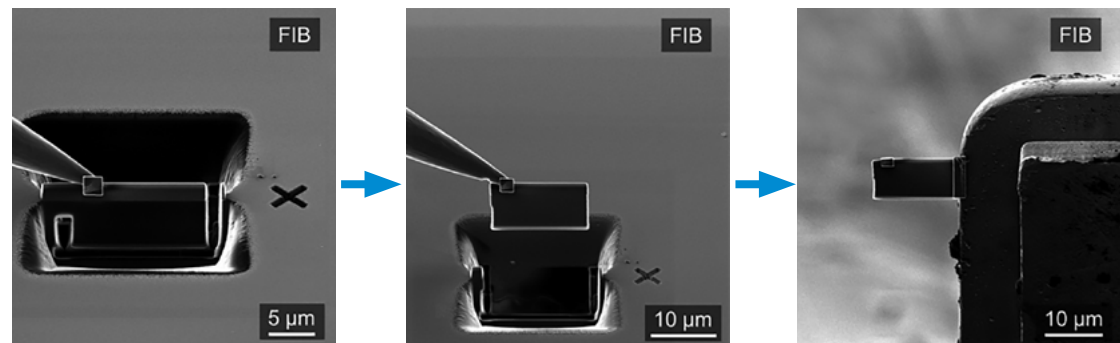

*Attach the needle of the micromanipulator to the lamella, lift it out of the bulk and attach it to the TEM-grid for further investigation in transmission mode. (from left to right)*

# Expand Your Possibilities

- › In Brief
- › **The Advantages**
- › The Applications
- › The System
- › Technology and Details
- › Service

## Keep Control During TEM Lamella Thinning

The final polishing step is crucial, as it defines the quality of your TEM lamella. When you aim to reach a desired thickness, the SEM allows live monitoring of the thinning. During imaging, the 'split mode' gives you the benefit of having the signals of several detectors available in parallel. Use the SE signal to judge lamella thickness and obtain reproducible end thickness. At the same time, the InLens SE signal helps you control surface quality.

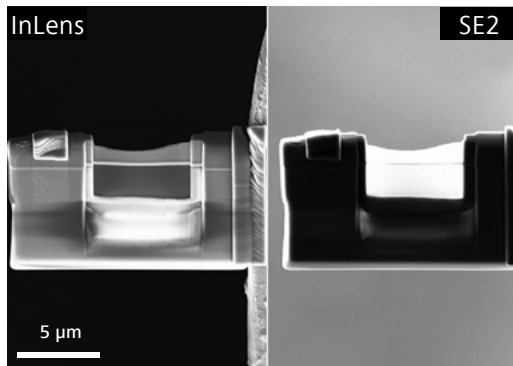

Keep full control during lamella thinning.

SmartEPD is an optional software module that allows you to determine the thickness of your TEM lamella quantitatively and thus stop the thinning process at your pre-defined endpoint, this time using the InLens EsB detector.

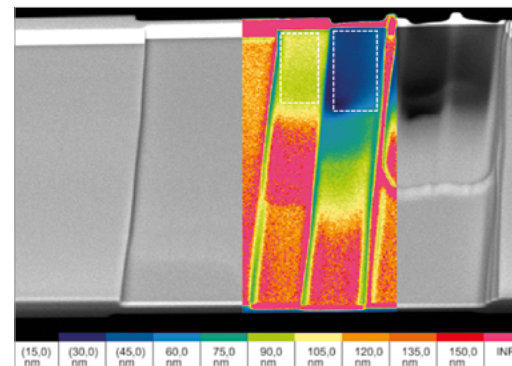

Use SmartEPD to determine the lamella thickness and endpoint of polishing quantitatively.

Even more benefits come your way with the x<sup>2</sup>- Holder, which is built to enable the preparation of ultra-thin lamellae. This is a big help when dealing with challenging samples that show intrinsic stress, for example, heterogeneous materials or polymers that would otherwise bend.



Use the patented X<sup>2</sup> preparation method to prepare ultra-thin, stable TEM lamellae and obtain a homogenous thickness of less than 10 nm without causing sample damage.

# Expand Your Possibilities

- › In Brief
- › **The Advantages**
- › The Applications
- › The System
- › Technology and Details
- › Service

## ZEISS Atlas 5 – Master Your Multi-scale Challenge

Use Atlas 5's sample-centric correlative environment to create comprehensive multi-scale, multi-modal images. This powerful yet intuitive hardware and software package extends the capacity of your Crossbeam. With its efficient navigation you can correlate images from any source.

For example, use X-ray volume data from your ZEISS X-ray microscope to target buried features of interest and analyze them in your Crossbeam. Take full advantage of Atlas 5's high throughput and automated large area imaging. Unique workflows will help you gain a deeper understanding of your sample. The modular structure lets you tailor Atlas 5 to your everyday needs in materials or life sciences research.



## Recommended Modules for Your Crossbeam

- NPVE Advanced (Advanced Nanopatterning & Visualization Engine): Perform nanopatterning with full control over patterning geometry and parameters.
- 3D Tomography: Turn your Crossbeam into a precise 3D FIB-SEM tomography acquisition engine with automated sample preparation. Automatically acquire 3D image data with up to several thousand images and a voxel resolution below 10 nm isotropic voxel size in 3D. Unique sample-tracking technology gives you the benefit of consistent slice thickness over long acquisitions. Meanwhile, robust autofocus and auto-stigmation algorithms keep all of your images sharp.
- Analytics: Add 3D EDS / 3D EBSD analytics to high resolution FIB-SEM tomography acquisition. Specify imaging and mapping conditions independently. Use the advanced acquisition engine to automatically switch between analysis and imaging conditions during acquisition. Flexible visualization allows you to simultaneously view SEM images and process elemental maps.

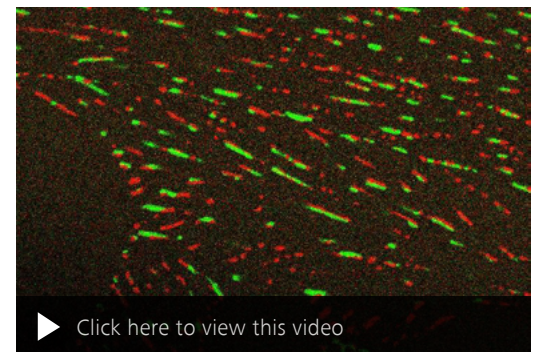

Tomography data of a lead free solder containing Cu and Ag particles in an Sn matrix. SEM images (top) and EDS maps (bottom) were acquired at the same sample site at 1.8 kV and 6 kV, respectively, with a ZEISS FIB-SEM and Atlas 5 Analytics. Courtesy of: M. Cantoni, EPFL Lausanne, Switzerland.

# Expand Your Possibilities

- › In Brief
- › **The Advantages**
- › The Applications
- › The System
- › Technology and Details
- › Service

## Fastmill – Speed Up Your Material Removal

Milling speed depends on a multitude of factors: target material, lattice orientation, ion current, milling geometry and so on. For a given material, your scanning strategy has the biggest impact on the material removal rate. During milling, sample topography changes are based on the precise milling strategy. This change, in turn, affects the milling rate.

Two milling styles are commonly distinguished: line and frame milling. In the first, the ion dose is delivered line by line in a single pass. In the latter, the entire frame is milled multiple times until the total dose is delivered. The local change of the sample surface in line milling dynamically alters the milling conditions – an effect that can be exploited to speed up material removal.

While line milling is potentially faster, redeposition fills up most of the trench and hence restricts the viewable cross-section. Targeting a specific cross-section depth requires experimentation and can be cumbersome. With Fastmill, a newly-introduced scanning strategy, milling speed is enhanced by optimally exploiting the angle-dependent sputtering effect. Fastmill enables up to 40 % faster milling than regular line milling. You need only activate one checkbox in the regular cross-sectioning or TEM prep workflow wizards.

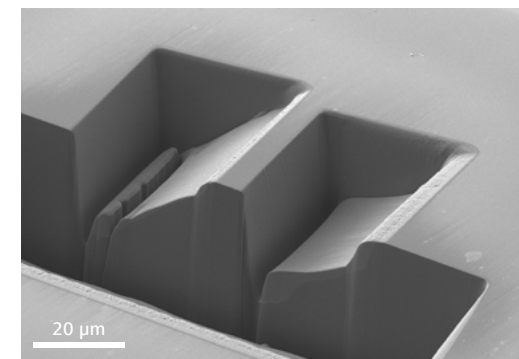

*Comparison of milling strategies in silicon. Material removal with conventional milling (left) takes 10 min 54 sec whereas with Fastmill the same amount of material is removed in 7 min 21 sec (right).*

# Expand Your Possibilities

- › In Brief
- › **The Advantages**
- › The Applications
- › The System
- › Technology and Details
- › Service

## ToF-SIMS enables High Throughput in 3D Analysis

Secondary Ion Mass Spectroscopy (SIMS) is an established means of analyzing surfaces that gives you excellent sensitivity and mass resolution, along with the ability to differentiate between isotopes. Adding ToF-SIMS (time of flight secondary ion mass spectrometry) to your Crossbeam brings unique analytical capabilities to the FIB-SEM.

## You will Benefit from:

- parallel detection of atomic and molecular ions down to the ppm level
- analysis of light elements, e.g. lithium
- analysis of isotopes
- analytical mapping and depth profiling
- better than 35 nm lateral resolution, 20 nm depth resolution
- post-mortem retrieval of any signal from the ROI

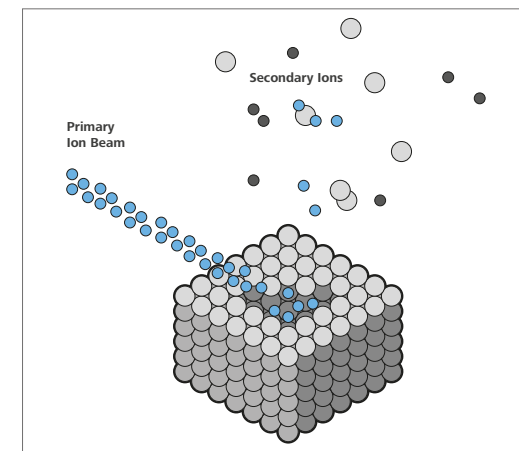

Working principle of SIMS: The Ga focused ion beam (blue) removes material from the top few nm of the sample surface. Different sputtered ion species (light and dark grey) are collected and transferred to the ToF-SIMS detector.

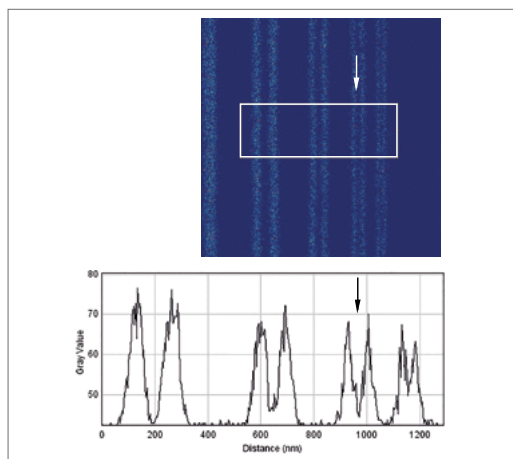

Top: Al (27 amu) map of a calibrated BAM L200 sample. The FOV is 2  $\mu\text{m}$ . Bottom: Line profile for the area within the green frame. Lines with a width and separation of 33.75 nm can be resolved clearly (arrows).

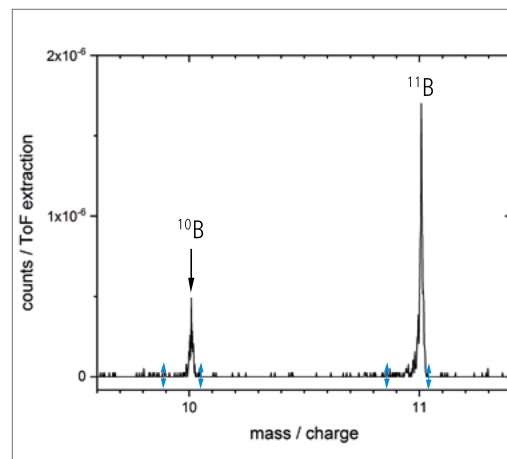

SIMS spectrum of boron doped silicon. The peaks at 10 and 11 amu correspond to the two isotopes of boron. The concentration of  $^{10}\text{B}$  is below 4.2 ppm.

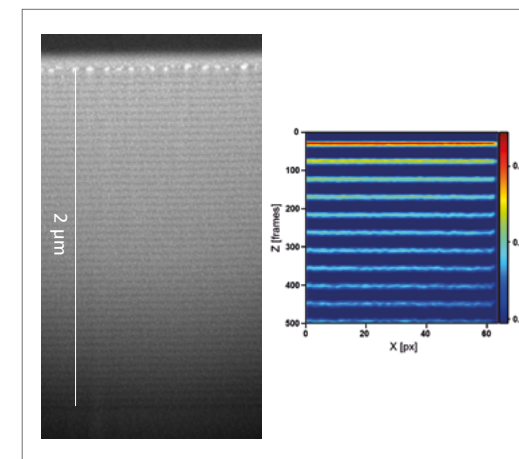

Left: SEM image of the cross section of an AlAs/GaAs multilayer system. The AlAs layers are 10 nm thick. Right: Corresponding SIMS depth profile showing the aluminum signal at 27 amu for the top 11 layers.

# Expand Your Possibilities

- › In Brief
- › **The Advantages**
- › The Applications
- › The System
- › Technology and Details
- › Service

## Gemini's Novel Optics – Profit from Surface Sensitive Imaging

High resolution imaging at low landing energy has become standard in SEM applications. It is not only required for beam sensitive samples and for non-conductive materials, it is also applied for gaining true surface information without undesirable background signal from deeper sample layers. SEM imaging performance of the Gemini optics is optimized dramatically at low and very low voltages through the introduction of a novel optical design. It includes a high resolution gun mode which results in the reduction of the primary beam energy width by 30%. And that is finally responsible for the advances in resolution.

Additionally, a two-step deceleration modus, the so-called Tandem decel, is introduced with the novel optical design of Gemini columns. The electron optical column of ZEISS FE-SEMs have an integrated beam deceleration by design using the beam booster technology. Now, an additional external sample biasing further improves low voltage resolution and contrast. A high negative bias voltage is applied to the sample, which decelerates the electrons of the primary electron beam, thus effectively reducing landing energy:

$$E_{\text{landing}} = E_{\text{primary}} - E_{\text{bias}}$$

The Tandem decel mode can be used in two different application modes: one for contrast enhancement by applying a variable negative bias voltage between 50 V and 100 V and the second enables low voltage resolution improvement by applying a negative bias voltage of 4 different fixed values of 1 kV, 2 kV, 3 kV or 5 kV.

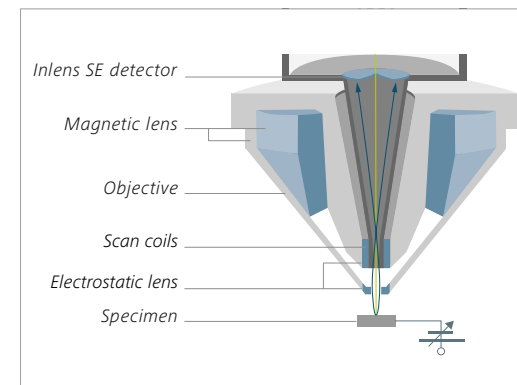

Sample biasing applies a voltage of up to 5 kV, using the optional feature Tandem decel, and improves imaging with the Gemini lens at low voltages even further.

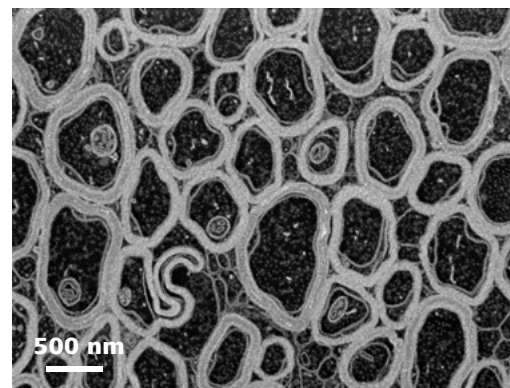
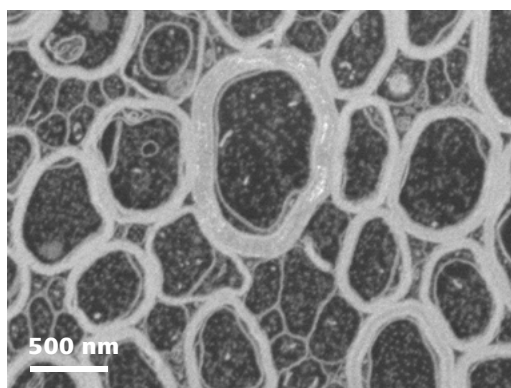

Brain tissue sample, showing numerous nerves that are surrounded by layers of special molecules for insulation, the myelin sheaths. Imaged at 1 kV without (left) and with Tandem decel (right). With the bias activated the myelin sheaths are clearly visible. Sample courtesy of: M. Cantoni, EPFL Lausanne, CH.



Tandem decel sample holder for 9 single specimens.

# Expand Your Possibilities

- › In Brief
- › **The Advantages**
- › The Applications
- › The System
- › Technology and Details
- › Service

## Make the Most of Your Crossbeam

Start smart, without that time-consuming search for the region of interest on your sample: take advantage of the optional navigation camera on the airlock. Locate specimens or specific sites, even in color. The integrated user interface makes it easy to navigate to your ROI. Select the large airlock and handle wafers of up to 8-inch diameter with fast sample transfer times.

Because it can be configured with two chamber sizes, Crossbeam 550 guarantees a high level of flexibility. The large chamber lets you customize your Crossbeam with a wider range of imaging, analytical and sample modification capabilities. Opt for a multi-channel gas injection system (GIS) to inject up to five different gases or configure your Crossbeam with up to two single GIS systems.

The large chamber offers you the possibility of configuring three pneumatically-driven accessories simultaneously, e.g. an aSTEM (annular scanning transmission electron microscopy) detector, an annular backscatter detector and a local charge compensation.

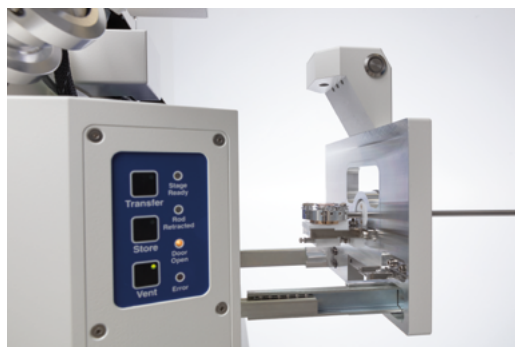

*The navigation camera on the airlock helps you find your region of interest quickly and easily.*

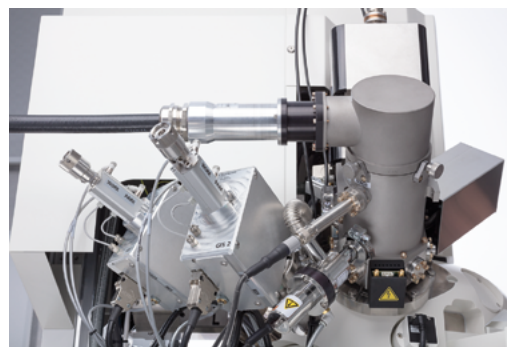

*Crossbeam equipped with two Uni-GIS units, both configured for optimal access angles to achieve optimal depositions.*



[▶ Click here to view this video](#)

*Take high resolution images in transmission mode with the STEM detector and exploit all contrast mechanisms from brightfield to high angular annular darkfield.*

# Tailored Precisely to Your Applications

- › In Brief
- › The Advantages
- › **The Applications**
- › The System
- › Technology and Details
- › Service

Typical Applications, Typical Samples	Task	ZEISS Crossbeam Offers
<b>Cross-sectioning</b>	Acquire high resolution images of cross-sections to obtain sub-surface information.	Crossbeam offers a wide range of detectors for a comprehensive characterization of your sample. Up to four detector signals can be acquired simultaneously to get more information at the same time. The Gemini lens design does not expose your sample to a magnetic field. It allows distortion free imaging of large fields of view. Coupled with image frame store resolutions of up to 50 k × 40 k pixel your Crossbeam is ideal for large area mapping applications.
<b>FIB-SEM Tomography</b>	Perform serial cross-sectioning to image and reconstruct volumes of your sample.	The InLens EsB detector provides excellent material contrasts and allows surface sensitive imaging because it reduces the information depth to only a few nanometers. When used during milling with the focused ion beam, it speeds up long-term experiments. Intelligent software solutions enable long and unattended tomography runs for reliable and precise results in the shortest time.
<b>FIB-SEM Tomography in Life Sciences</b>	Acquire high resolution images of your cross-section or perform large volume tomography for morphological analysis.	Precisely target, image and reconstruct the volume of interest to get 3D information from your biological samples.
<b>3D Analytics</b>	Study the chemical and crystallographic microstructure of your sample.	Crossbeam is the perfect tool for 3D EDS and 3D EBSD analysis of your sample. Different packages are provided for fully automated acquisition of the 3D datasets.
<b>TEM Sample Preparation</b>	Prepare thin lamellae for their analysis in TEM or STEM.	Crossbeam offers a complete solution for preparing TEM lamellae, even for batches. Profit from the low voltage performance of the Ion-sculptor FIB column in gaining high quality lamella and avoid amorphization of delicate specimens. Use a simple three-step workflow to get started and wait for automatic execution. For preparing high quality lamellae, use the patented X <sup>2</sup> sample holder during final thinning. Profit from an endpoint detection software that gives you accurate information about the thickness of your lamella.
<b>Nanopatterning</b>	Create new structures or modify existing structures by FIB (or SEM) and different gases.	Perform FIB patterning tasks with full SEM control in real time. Just choose and draw the shapes you want to create on your FIB image, set up the parameters and start patterning. The system's user-friendly software helps inexperienced users to achieve great results. For most advanced fabrication tasks, the software allows you to access all relevant SEM, FIB or GIS parameters to tailor the best FIB patterning strategy at single object level. You can plan and create your FIB exposure work offline.
<b>Surface sensitive analysis of batteries or polymers</b>	Characterize the composition of the first few atom layers of solid surfaces.	Adding the ToF-SIMS spectrometer lets you analyze trace elements such as lithium, detect isotopes, and perform elemental mapping and depth profiling with a lateral analytical resolution down to 35 nm.
<b>Gain speed and quality in <i>in situ</i> studies</b>	Localize and access deeply buried structures quickly	Add a femtosecond laser to your Crossbeam, find hidden ROIs using the correlative workspace GUI in ZEISS Atlas 5 e.g. with XRM datasets, ablate materials quickly and safely with the femtosecond laser.



# ZEISS Crossbeam at Work

- › In Brief
- › The Advantages
- › **The Applications**
- › The System
- › Technology and Details
- › Service

## Nanopatterning



Live imaging while milling a spiral: SE signal (left), Inlens SE (right).

## SEM Imaging

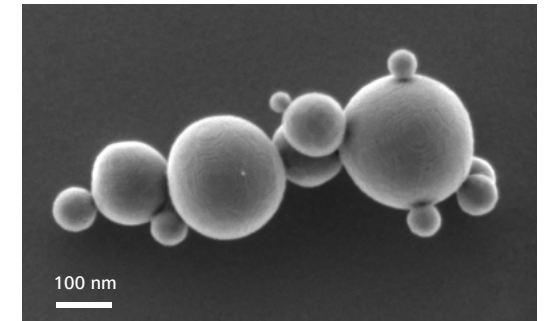

Alumina nanospheres imaged at 1 kV and FIB-SEM coincidence point with Tandem decel exemplifies high resolution, surface sensitive imaging of challenging samples.

## Cross-sectioning and 3D Analysis

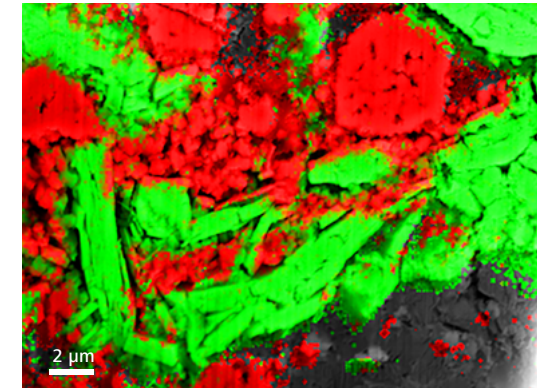
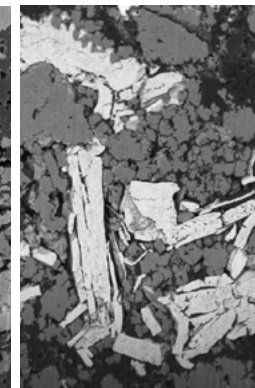
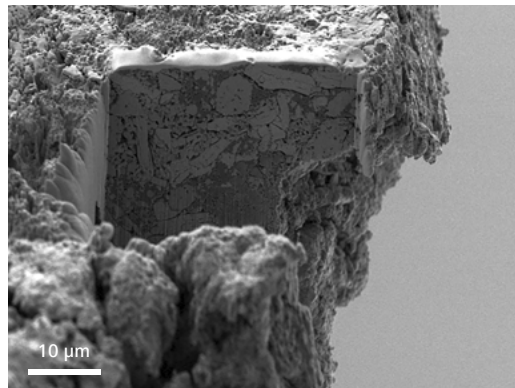

$\text{LiMn}_2\text{O}_4$  cathode material of a lithium ion battery. Close-up of cross-section shows surface information on an Inlens SE image and unique, pure materials contrast with an Inlens EsB image. The distribution of lanthanum (red) and manganese (green) is derived from an EDS map (from left to right).

# ZEISS Crossbeam at Work

- › In Brief
- › The Advantages
- › **The Applications**
- › The System
- › Technology and Details
- › Service

## Nanopatterning

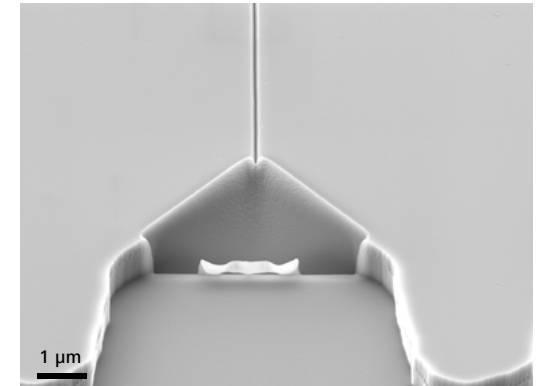
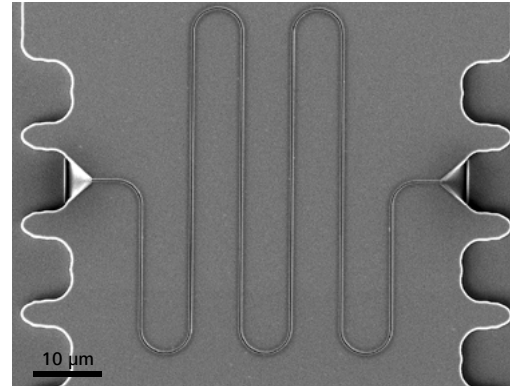
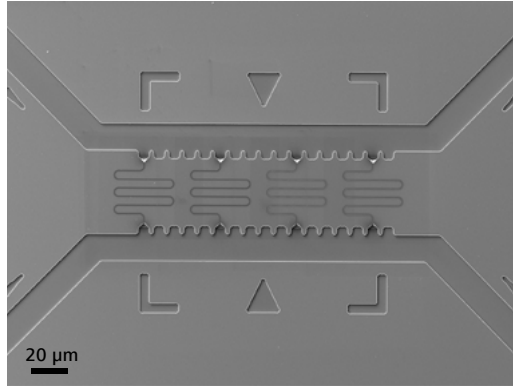

Nanofluidics channels fabricated by FIB in a silicon master stamp (left). Detail: meander-shaped channel (center). Inlets and outlets have a funnel shape (right). Courtesy of: I. Fernández-Cuesta, INF Hamburg, Germany.

## Milling

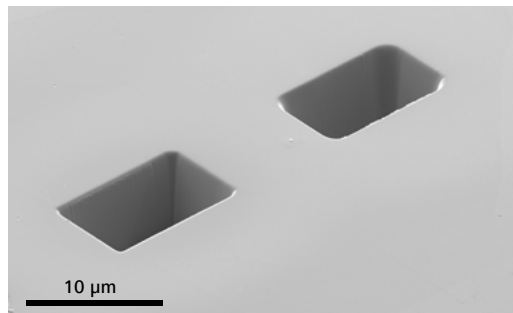

Trenches milled in high entropy alloy, dimensions 25 μm × 15 μm, milling time 3 minutes for 65 nA box (right) and 11 minutes for 30 nA box (left).

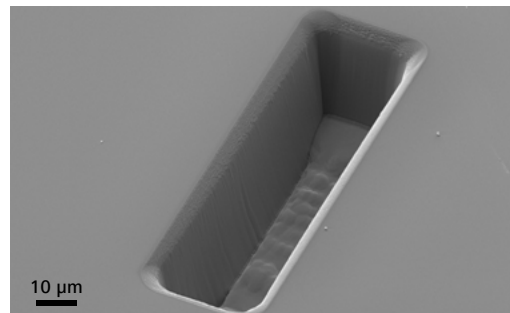

Trench milled in silicon, dimensions 100 × 30 × 25 μm<sup>3</sup>, milling time 10 minutes using 100 nA FIB current.

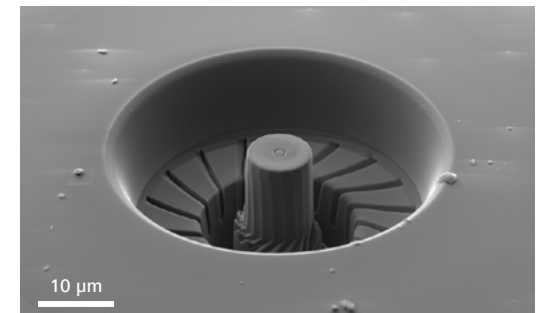

Pillar for compression testing after being machined using lathe milling.

# ZEISS Crossbeam at Work

- › In Brief
- › The Advantages
- › **The Applications**
- › The System
- › Technology and Details
- › Service

## TEM Sample Preparation

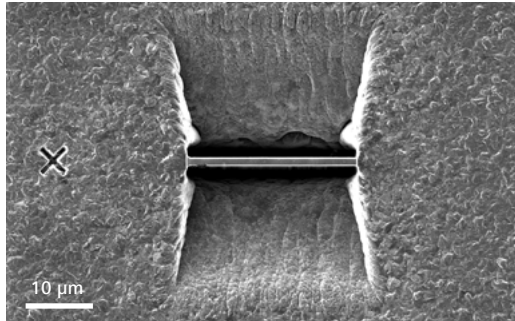

Lamella of a copper sample ready for lift out, fabricated with automatic sample preparation, prepared and imaged by FIB. Scale bar: 10  $\mu\text{m}$ .

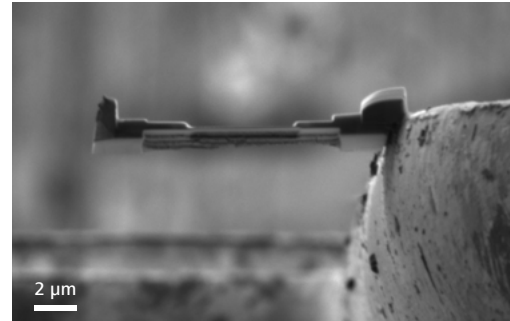

Ion-sculptor 5kV image of a lamella of poly-crystalline silicon. High imaging quality at low voltages allows precise thinning of the central region of the lamella. Scale bar: 2  $\mu\text{m}$ .

## Preparation of Sample Batches

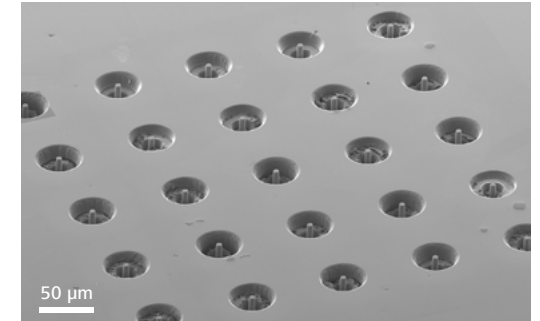

Array of compression testing pillars in high entropy alloy, machined fully automatically. Scale bar: 50  $\mu\text{m}$ .

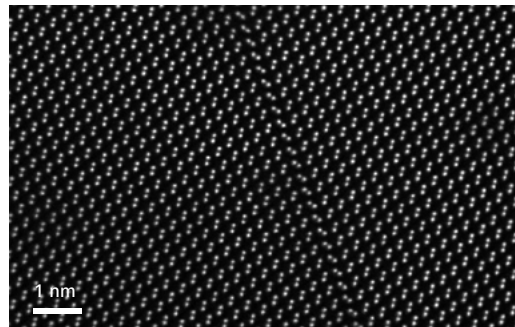

Silicon in  $\langle 110 \rangle$  orientation, STEM image of a FIB lamella in a TEM.  $\langle 110 \rangle$  silicon dumbbells and a twin boundary are clearly visible. The TEM lamella was prepared with the Ion-sculptor FIB of ZEISS Crossbeam 550 with low kV thinning. Image Courtesy of: C. Downing, CRANN Institute, Trinity College, Dublin, Ireland. Nion UltraSTEM 200. Scale bar: 1 nm.

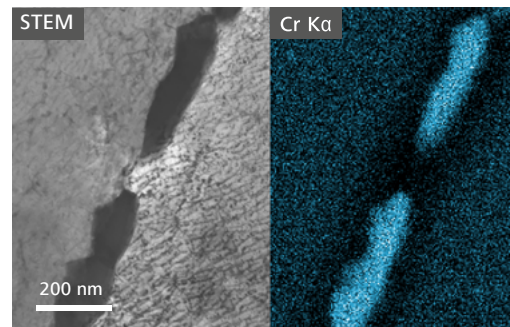

Chromium carbides at the grain boundary of thermally-affected X2CrNi18-10 steel: STEM BF in a FIB-SEM (left), EDS chromium map (right). Scale bar: 200 nm.

## LaserFIB preparation

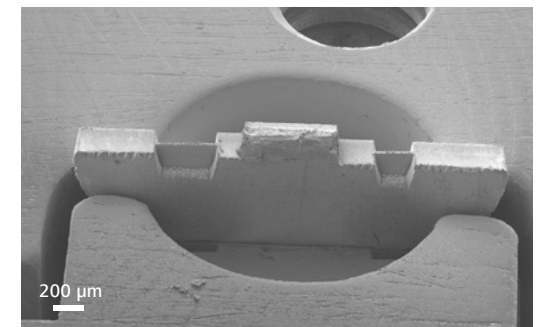

H-bar lamella preparation by fs-laser on a copper semi-circle grid. The left lamella is 400  $\mu\text{m}$  wide, 215  $\mu\text{m}$  deep and has a thickness of about 20  $\mu\text{m}$  at the top. It was cut by the laser in 34 s. The amount of material that needs to be removed by FIB for final thinning is significantly reduced. Scale bar: 200  $\mu\text{m}$ .

# ZEISS Crossbeam at Work

- › In Brief
- › The Advantages
- › **The Applications**
- › The System
- › Technology and Details
- › Service

## FIB – Tomography in Life Sciences Cell Biology – HeLa Cells



Investigation of different cell compartments in single cells. Individual HeLa cells were grown in culture dishes, chemically-fixed and resin-embedded in EPON. Voxel size  $5 \times 5 \times 8$  nm, InLens EsB detection, 1400 sections. 3D visualization with Dragonfly Pro, ORS. Courtesy: A. Steyer and Y. Schwab, EMBL, Heidelberg, DE.

## Cell Biology – Algae

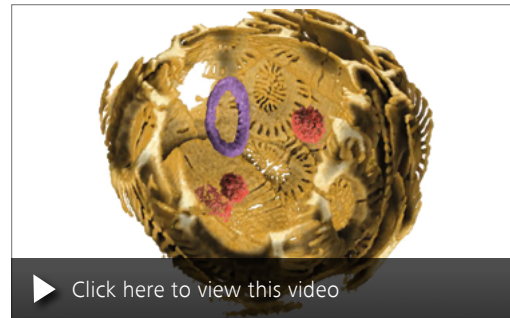

3D reconstruction of a vitrified *Emiliana huxleyi* coccolithophore obtained from a cryo-FIB-SEM image series. The 3D reconstruction shows the immature coccolith (in yellowish), a coccolith in statu nascendi (blue) and lipid bodies (red). Courtesy: L. Bertinetti, Max-Planck Institute of Colloids and Interfaces, Potsdam, DE and A. Scheffler, Max-Planck Institute Plant Physiology, Potsdam, DE.

## Neuroscience – Brain Sections



Large area milling and imaging of a brain section with the 3D module of ZEISS Atlas 5. High current allows fast milling and imaging of large fields of view up to  $150 \mu\text{m}$  in width. The depicted brain image has a field of view of  $75 \mu\text{m}$  in width and was milled with a beam current of 20 nA. Courtesy: C. Genoud, FMI Basel, CH.

## Developmental Biology – *C.elegans*

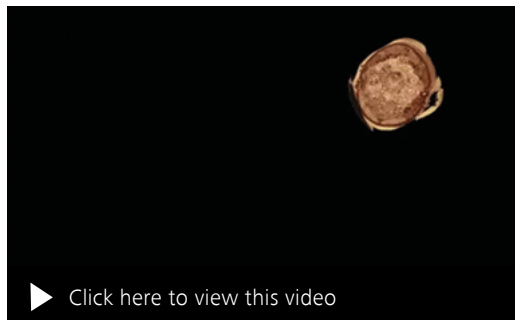

Understanding the morphology of a whole organism in 3D with the highest resolution and reliability. The data set shows a large 3D volume of *C.elegans* consisting of 10.080 z-sections at  $5 \times 5 \times 8$  nm pixel size. The nematode was high pressure frozen and freeze-substituted in EPON. Even the smallest structures inside the worm can be identified very easily. Courtesy: A. Steyer and Y. Schwab, EMBL Heidelberg, DE; and S. Markert and C. Stigloher, University of Wuerzburg, DE.

## Microbiology – *Trypanosoma*

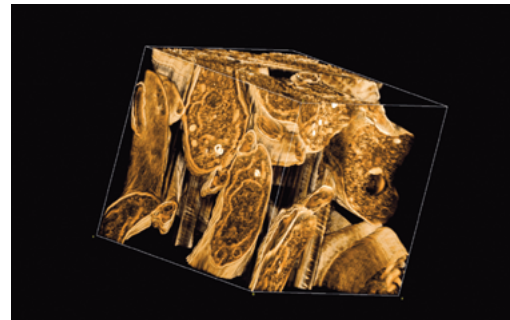

Ultrastructural investigation of the parasite *Trypanosoma brucei*. The cells are high pressure frozen and freeze-substituted in EPON. Acquisition of 800 z-sections which corresponds to  $\sim 8 \mu\text{m}$  thickness in z; pixel size in x/y is 5 nm. Sample courtesy: S. Vaughan, Oxford Brookes University, Research Group 'Cell biology of Trypanosomes', UK.

# Your Flexible Choice of Components

- › In Brief
- › The Advantages
- › The Applications
- › **The System**
- › Technology and Details
- › Service

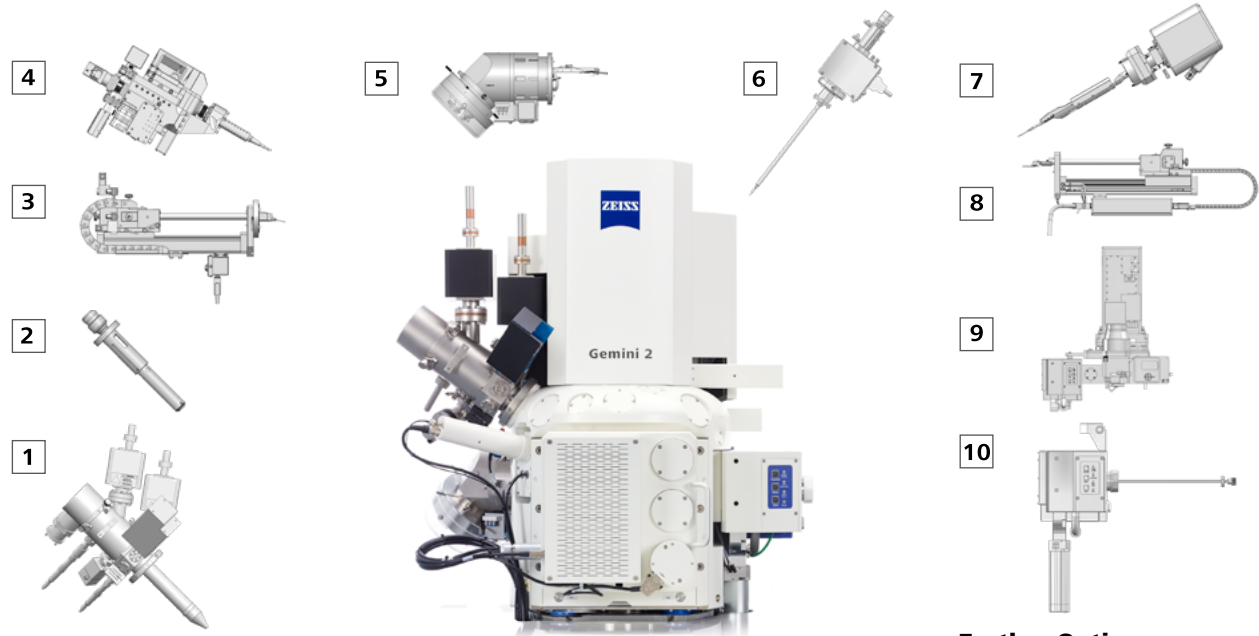

## Available Options

1. Focused Ion Beam (FIB) column
2. Electron flood gun allows ion beam preparation of non-conductive samples
3. Local charge compensation allows SEM imaging and analysis of non-conductive samples
4. Retractable ToF-SIMS spectrometer for parallel mass detection with excellent spatial resolution
5. Multichannel Gas Injection system (GIS) for up to 5 precursor materials on a single flange
6. Uni-GIS for high angle sample access, two systems configurable

7. Manipulators for sample handling and probing
8. Annular STEM for high resolution transmission imaging or aBSD4 detector for high efficiency and angle selective material characterization
9. Femtosecond laser for massive material ablation
10. Airlock solution (80 mm or 200 mm sample size) for fast and efficient sample transfer and fast pumping times with integrated navigation camera

## Further Options

- Inlens EsB detector for high resolution without topographic artifacts and unique material contrast
- SESI detector for secondary electron and secondary ion imaging
- Atlas 5 for advanced tomography, patterning and EDS and EBSD analytics in 3D
- Plasma cleaner
- Electrostatic beam blunker for SEM
- Tandem decel for enhanced resolution and contrast at low voltages for suitable samples
- Analytic detectors: EDS, WDS, EBSD
- 34 inch, 21:9, ultra-wide screen monitor

# Technical Specifications

- › In Brief
- › The Advantages
- › The Applications
- › The System
- › **Technology and Details**
- › Service

	ZEISS Crossbeam 350	ZEISS Crossbeam 550	
<b>SEM</b>	Schottky Emitter	Schottky Emitter	
	1.7 nm @ 1 kV	1.4 nm @ 1 kV	
	1.5 nm @ 1 kV with Tandem decel	1.2 nm @ 1 kV with Tandem decel	
	1.9 nm @ 200 V with Tandem decel	1.6 nm @200 V with Tandem decel	
	0.9 nm @ 15 kV	0.7 nm @ 15 kV	
	0.7 nm @ 30 kV (STEM mode)	0.6 nm @ 30 kV (STEM mode)	
	2.3 nm @ 1 kV (WD 5 mm)	1.8 nm @ 1 kV (WD 5 mm)	
	1.7 nm @ 1 kV with Tandem decel (WD 5 mm)	1.3 nm @ 1 kV with Tandem decel (WD 5 mm)	
	1.1 nm @ 15kV (WD 5 mm)	0.9 nm @ 15kV (WD 5 mm)	
	2.3 nm @20 kV & 10 nA (WD 5 mm)	2.3 nm @20 kV & 10 nA (WD 5mm)	
Beam current: 5 pA – 100 nA	Beam current: 10 pA – 100 nA		
<b>FIB</b>	LMIS: Lifetime: 3000 µAh	LMIS: Lifetime: 3000 µAh	
	Resolution: 3 nm @ 30 kV (statistical method)	Resolution: 3 nm @ 30 kV (statistical method)	
	Resolution: 120 nm @ 1 kV & 10 pA (optional)	Resolution: 120 nm @ 1 kV & 10 pA	
<b>Detectors</b>	Inlens SE, Inlens EsB, VPSE (Variable pressure secondary electron detector), SESI (secondary electron secondary ion), aSTEM (scanning transmission electron), aBSD (backscatter detector)	Inlens SE, Inlens EsB, ETD (Everhard-Thornley detector), SESI (secondary electron, secondary ion), aSTEM (scanning transmission electron), aBSD (backscatter detector), CL (cathodoluminescence)	
<b>Chamber Size and Ports</b>	Standard with 18 configurable ports	Standard with 18 configurable ports	Large with 22 configurable ports
<b>Stage</b>	X/Y = 100 mm	X/Y = 100 mm	X / Y = 153 mm
	Z = 50 mm, Z' = 13 mm	Z = 50 mm, Z' = 13 mm	Z = 50 mm, Z' = 20 mm
	T = -4° to 70°, R = 360°	T = -4° to 70°, R = 360°	T = -15° to 70°, R = 360°
<b>Charge Control</b>	Flood Gun	Flood Gun	
	Local Charge Compensation	Local Charge Compensation	
	Variable Pressure	-	
<b>Gases</b>	Uni-GIS: Pt, C, SiO <sub>x</sub> , W, H <sub>2</sub> O	Uni-GIS: Pt, C, SiO <sub>x</sub> , W, H <sub>2</sub> O	
	Multi-GIS: Pt, C, W, Au, H <sub>2</sub> O, SiO <sub>x</sub> , XeF <sub>2</sub>	Multi-GIS: Pt, C, W, Au, H <sub>2</sub> O, SiO <sub>x</sub> , XeF <sub>2</sub>	

# Technical Specifications

- › In Brief
- › The Advantages
- › The Applications
- › The System
- › **Technology and Details**
- › Service

	ZEISS Crossbeam 350	ZEISS Crossbeam 550
<b>Store Resolution</b>	32 k × 24 k (up to 50 k × 40 k with optional Atlas 5 3D Tomography module)	32 k × 24 k (up to 50 k × 40 k with optional Atlas 5 3D Tomography module)
<b>Analytic Options</b>	EDS, EBSD, WDS, SIMS, others on request	EDS, EBSD, WDS, SIMS, others on request
<b>Advantages</b>	Maximum sample variety due to variable pressure mode, wide range of <i>in situ</i> experiments.	High throughput in analytics and imaging, high resolution under all conditions.
<b>Retractable ToF-SIMS Spectrometer</b>		
<b>Detection Limit</b>	< 4,2 ppm boron in silicon	
<b>Lateral Resolution</b>	< 35 nm	
<b>Mass/Charge Range</b>	1-500 Th	
<b>Mass Resolution</b>	m/Δm > 500 FWTM	
<b>Depth Resolution</b>	< 20nm AlAs/GaAs multilayer system	
<b>Femtosecond Laser</b>		
<b>Type</b>	DPSS	
<b>Wavelength (λ)</b>	515 nm (green)	
<b>Optics</b>	telecentric	
<b>Pulse Duration</b>	<350 fs	
<b>Spot Size</b>	<15 μm	
<b>Scan Field Size</b>	40 × 40 mm <sup>2</sup>	

# Count on Service in the True Sense of the Word

- › In Brief
- › The Advantages
- › The Applications
- › The System
- › Technology and Details
- › **Service**

Because the ZEISS microscope system is one of your most important tools, we make sure it is always ready to perform. What's more, we'll see to it that you are employing all the options that get the best from your microscope. You can choose from a range of service products, each delivered by highly qualified ZEISS specialists who will support you long beyond the purchase of your system. Our aim is to enable you to experience those special moments that inspire your work.

## **Repair. Maintain. Optimize.**

Attain maximum uptime with your microscope. A ZEISS Protect Service Agreement lets you budget for operating costs, all the while reducing costly downtime and achieving the best results through the improved performance of your system. Choose from service agreements designed to give you a range of options and control levels. We'll work with you to select the service program that addresses your system needs and usage requirements, in line with your organization's standard practices.

Our service on-demand also brings you distinct advantages. ZEISS service staff will analyze issues at hand and resolve them – whether using remote maintenance software or working on site.

## **Enhance Your Microscope System.**

Your ZEISS microscope system is designed for a variety of updates: open interfaces allow you to maintain a high technological level at all times. As a result you'll work more efficiently now, while extending the productive lifetime of your microscope as new update possibilities come on stream.



*Profit from the optimized performance of your microscope system with services from ZEISS – now and for years to come.*

>> [www.zeiss.com/microservice](http://www.zeiss.com/microservice)





**Carl Zeiss Microscopy GmbH**  
07745 Jena, Germany  
microscopy@zeiss.com  
www.zeiss.com/crossbeam