

The PALM Family

A New Dimension in Sample Purity



Integrated Laser Microdissection and Microscope Systems
for Live Cells and Fixed Material



We make it visible.

At the Forefront of Science

The biomedical sciences with their rapid development rate is one of the most meaningful and promising research fields. Increasingly efficient technologies are leading to a deeper understanding of the complex mechanisms that underlie living systems at the molecular, cellular and tissue level.

For more than 160 years Carl Zeiss has been at the forefront of research and development in advanced optical technologies. Excellence in support, but above all, an understanding of the individual needs of scientists means we can create the best environment for successful research.

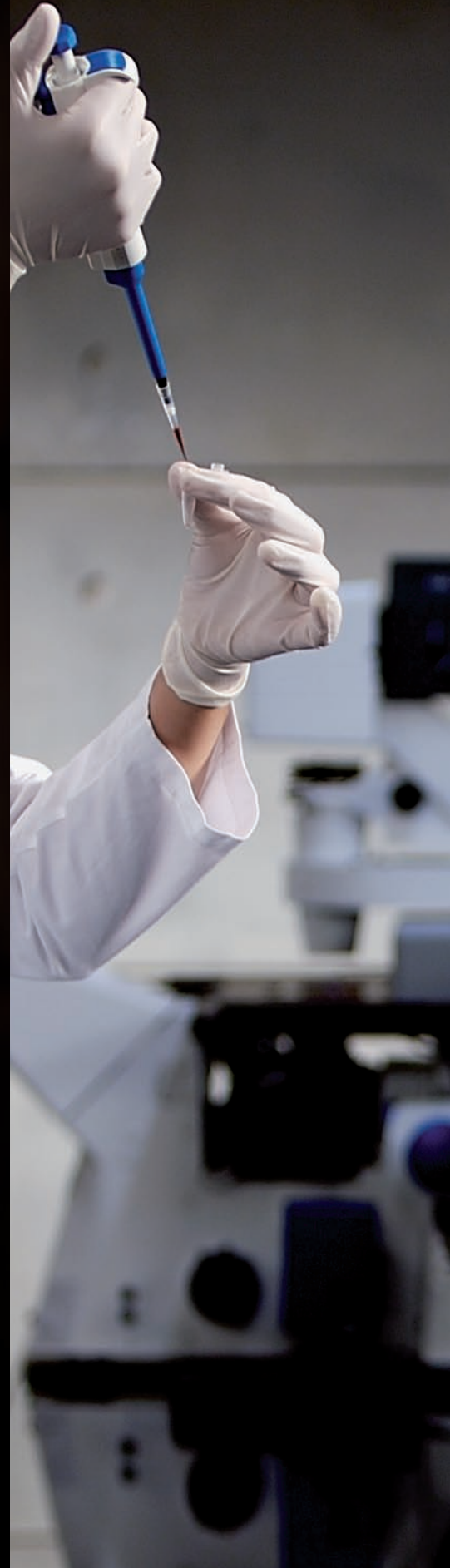





Sample Purity: The Key Factor in Science

The isolation of single cells and cell groups, as well as biomolecules, is central to life sciences. For biomedical analysis a method is required for the extraction of your samples, particularly with heterogeneous tissue, that is free of contamination and guarantees preservation of the material.

Clearly the preparation and staining of samples as well as the actual analyses are critical processes. However, in molecular biological analysis methods such as PCR, separation of the desired elements is of critical importance and requires the maximum precision and purity. Sample purity is the deciding factor for the success of your research.



Laser Technology Is the Key

Due to its precise contact-free laser technology the microdissection process from Carl Zeiss is the quickest and safest method to extract absolutely pure and undamaged samples.

With its user-friendly software and application-dedicated technology, laser microdissection from Carl Zeiss is simple to use. After selection, the specimen is separated from the tissue by the laser and subsequently transported into the collection device with a targeted laser pulse.

For the manipulation and sorting of cells at the microscopic level, Carl Zeiss also offers an innovative laser trapping process that has become a standard in biotechnology and life science research.

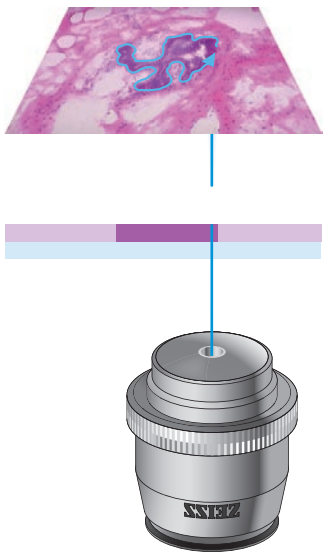

The laser separates the desired sample from the surrounding specimen.

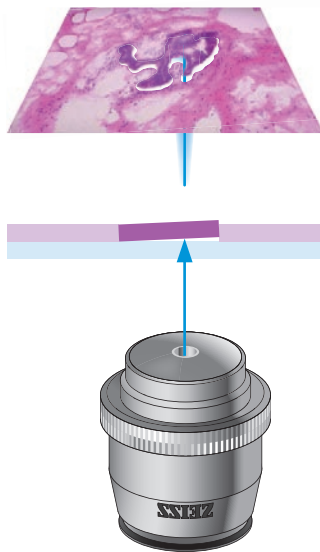

Sample capture is initiated using a single laser pulse.

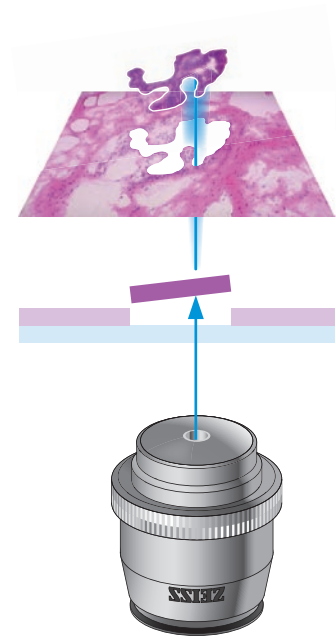

The ejected sample is transferred to the desired capture device.



Expertise

As a leading provider of laser microdissection technology, we never underestimate the importance of customer support. Our application laboratories provide you with an unparalleled level of know-how and expert advice. We offer comprehensive application consultation as well as uncomplicated technical support through everyday use of the PALM system from Carl Zeiss.

Furthermore, at our headquarters, a highly qualified lab team works constantly on the development of new applications and the validation of new methods in our optimally equipped research facility.

More Efficient Experiments with Fixed Material

The fundamental starting point for the majority of bioanalytical methods is a high quality sample comprising intact biomolecules.

In order to conduct a detailed examination of gene expression from tissue, the condition of the source material is critical. If the specimen is heterogeneous by nature then its analysis will result in a harder to interpret, mixed gene profile. With the process from Carl Zeiss the absolute purity of the sample and the highest efficiency of your experiment is ensured.

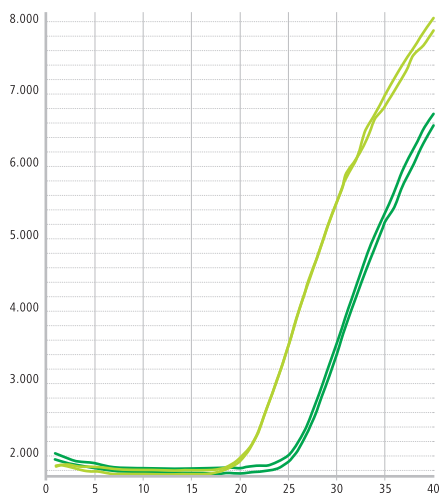

Real-Time PCR of AMACR as marker of prostate carcinoma from laser microdissected material

Light green: tumor sample
Dark green: adjacent normal tissues



Dr. rer. nat. Olaf J. C. Hellwinkel, Head of Molecular Biology, Martini-Klinik at the University Medical Center Hamburg-Eppendorf

"We studied gene activities of various important members of the PIK3-PKB-pathway for alterations in prostate carcinoma (PCA). By quantitative real-time PCRs, we analyzed transcript levels of 12 genes in laser microdissected tumor tissues from 20 patients of varying stages for differences compared to adjacent normal tissues and a pool of prostate tissues from healthy controls. Laser microdissection is the enabling technology to separate defined tissue areas for downstream analysis and leads to relevant results."

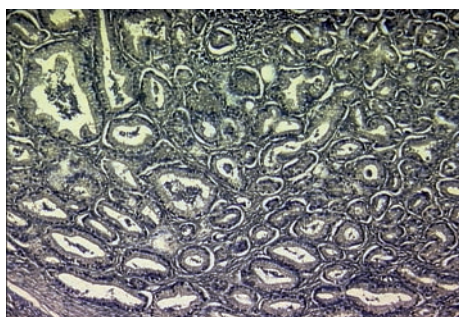

Prostate carcinoma, cresyl violet stain



The Generation of Homogeneous Cell Colonies

Positive Selection

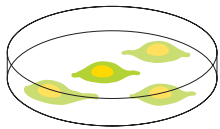

Cell culture

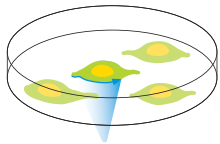

Laser cuts around the cell.

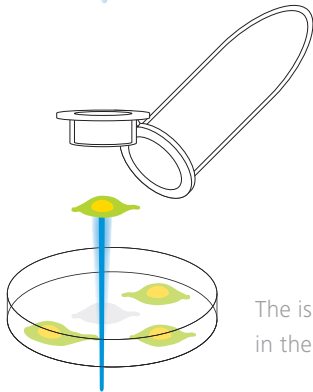

The isolated cell is captured in the collector...

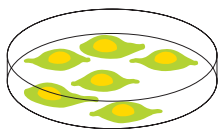

... and re-cultured.

Laser microdissection from Carl Zeiss represents a highly convenient method for the isolation and recovery of viable living cells from cell and tissue cultures. This fascinating process enables the analysis and re-cultivation even of extremely sensitive primary or stem cell cultures without risk of dilution or the use of trypsin. In a simple way you generate absolutely homogeneous cultures – even on the basis of a single cell.



Professor Helen M. Blau, Director of Baxter Laboratory in Genetic Pharmacology, School of Medicine, Department of Microbiology and Immunology and Stem Cell Institute, Stanford University

"The question of fundamental interest to my laboratory is how cells maintain their differentiated state, and how they can change in response to injury. Our research is directed at understanding stem cell quiescence, self-renewal, differentiation, and how cancer arises. To obtain information on dynamic analyses of cells, we decided to use the non-contact laser capture microdissection technology of Carl Zeiss. This allows us to investigate selected single captured cells in a manner previously not possible. The Holy Grail of our research is to be able to administer drugs to help to enlist the body to treat its own disease."

PALM MicroBeam

The workstation for ultra-pure sample isolation with integrated high performance imaging functionality.







ZEISS

PALM MicroBeam

PALM MicroBeam

ZEISS

ZEISS

PALM MicroTweezers

The dedicated instrument for contact-free micromanipulation with laser optical trapping.

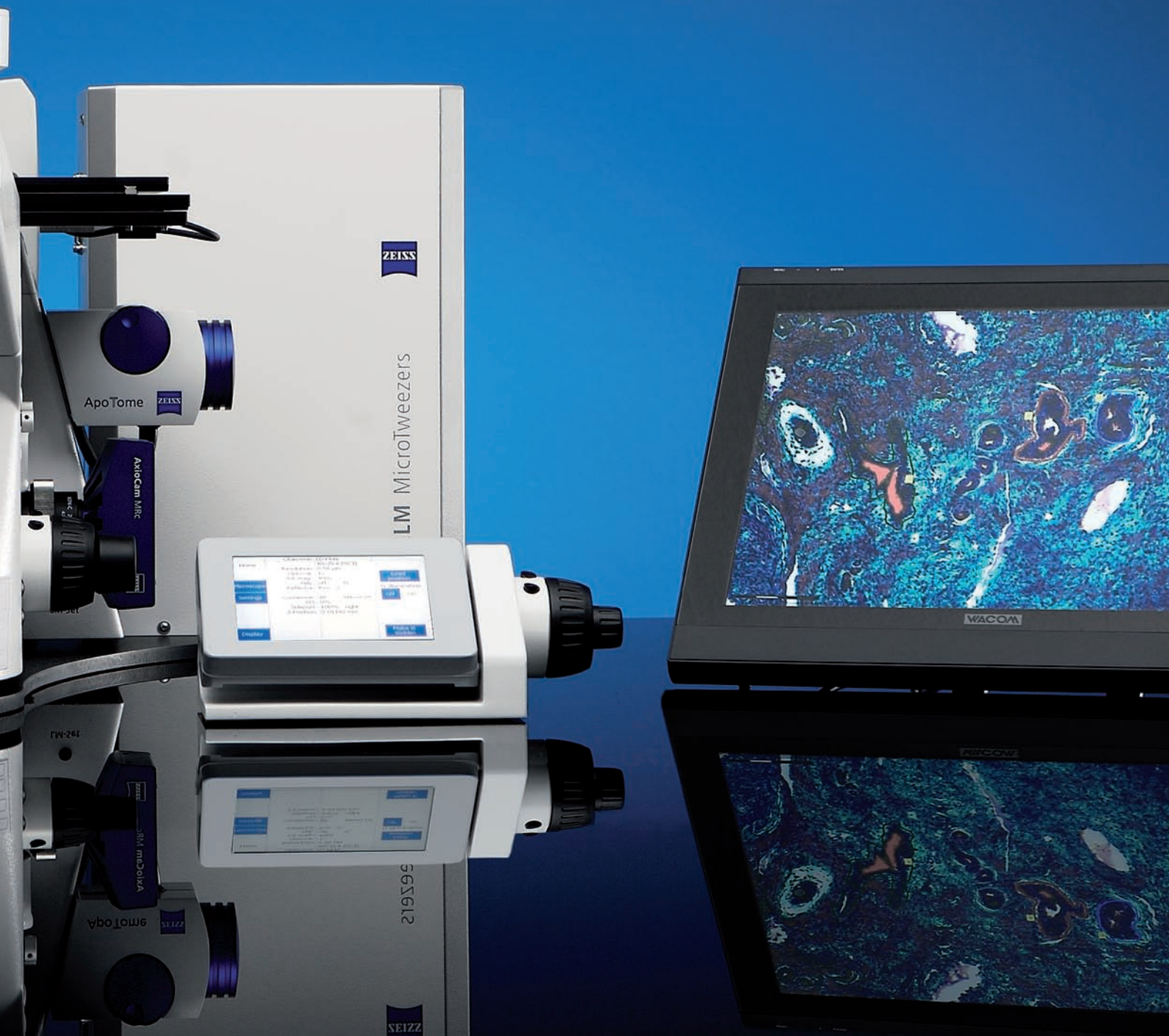



PALM CombiSystem

The flexible all-in-one platform for laser microdissection, laser optical trapping, or a combination of both.



PALM Laboratories

Leading-edge technology, first-class technical and applied know-how and a deep understanding of the demands of modern research.

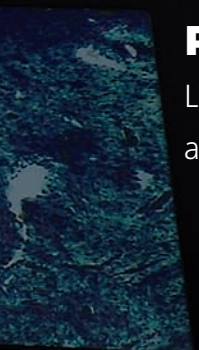

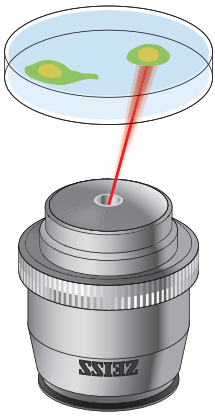

The laser traps the selected cell.

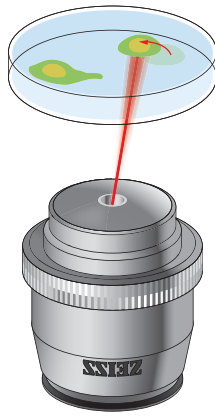

The cell can be moved within the medium...

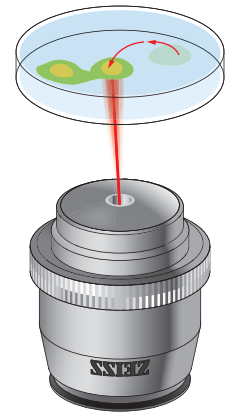

...towards a desired target.

Contact-free Micromanipulation

Optical Tweezers, also known as laser tweezers, are a highly effective and non-invasive method to manipulate cells as well as trap, move, and sort microscopic particles.

Using the force field of a highly focused laser beam (optical trap), manipulation functions are conducted without mechanical contact. Living cells can be manipulated either in isolation or amongst other cells without damage to their structure or function. The wavelength of the applied infra-red laser is 1064 nm and therefore within medical technology's "therapeutic window" of 600 nm to 1200 nm for preventing damage to living systems.

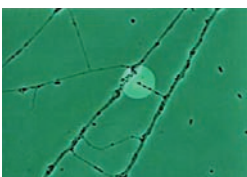
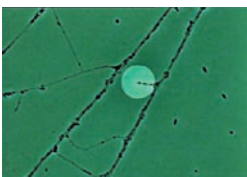
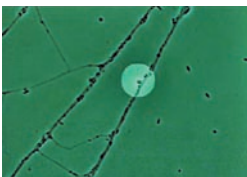

Literature

Ashkin, Arthur: *Optical trapping and manipulation of neutral particles using lasers*, Proc. Natl. Acad. Sci. Volume 94, pp. 4853–4860 (1997)

Kuyper, Christopher L. and Chiu, Daniel T.: *Optical trapping: A versatile technique for biomanipulation*, Applied Spectroscopy, Volume 56, Number 11: 300A–312A (2002)

Microdissection with a Laser

In PALM systems, separation of the specimen occurs with a laser beam focused so precisely that a beam accuracy of less than 1 μm can be achieved.

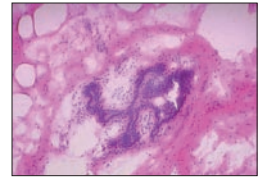
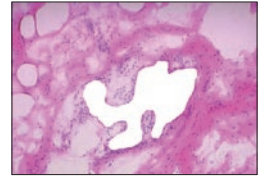

The selected specimen is separated with a software-controlled laser beam and transported by a laser pulse into a collection device. This procedure ensures that no unwanted elements are collected. Because the laser in the process is only directed at the sample for about 1 ns, it does not transfer any heat. The process is completely contact- and contamination-free and guarantees the best possible preservation of the material.

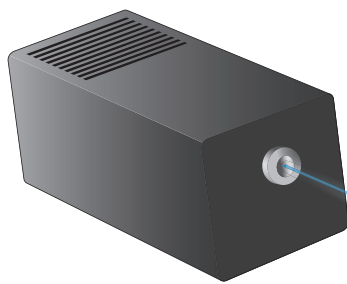

Literature

Horneffer, Verena; Linz, Norbert; Vogel, Alfred: *Principles of laser-induced separation and transport of living cells*, Journal of Biomedical Optics, 12 (5), 054016 September/October 2007



Optimal Solutions for Your Research

Our aim is to provide you with the best possible solutions for your research.

This begins with the proven high-quality processes and systems from Carl Zeiss. Beyond that, we offer you a special service with RentalLab: to save time, money, and resources you can rent our excellently equipped research facilities for your projects or allow our experts to perform the experiments completely.

Through the efficiency of our lab, we make it possible for you to reduce your workload to a minimum. Furthermore, through the practical work in our labs we gain knowledge that directly influences the continued development of our products and services as, for instance, in the constant optimization of the expendable materials for our systems.

Accessories and consumables for laser microdissection:

MembraneSlides – Improve the efficiency of laser microdissection, we have the right slide for your application: PEN, PET & nuclease-free.

Sample Collection – A range of capture consumables designed to fit your needs. Choose from AdhesiveCaps for dry collection to eight cap strips or even multititer plate format for high content experiments.

Live Cell Applications – A versatile range of dedicated cell culture plasticware is available to suit the demands of live cell culture, imaging, and laser microdissection. The LiveCell Collector is an accessory for the isolation of adherent live cells without additional trypsinization and under sterile conditions. Specialized DuplexDishes and MembraneRings are supplied in two sizes (50 mm and 35 mm). For greater capacity we also offer an insert for up to six Lumox™ dishes.

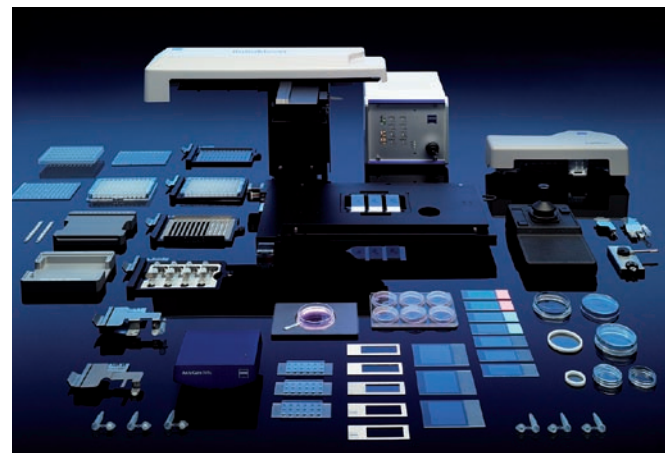

Automated Sample Extraction

CapMover and RoboMover are the fully automated and computer controlled collection devices of the PALM systems. They enable reliable and user friendly collection of specimens.

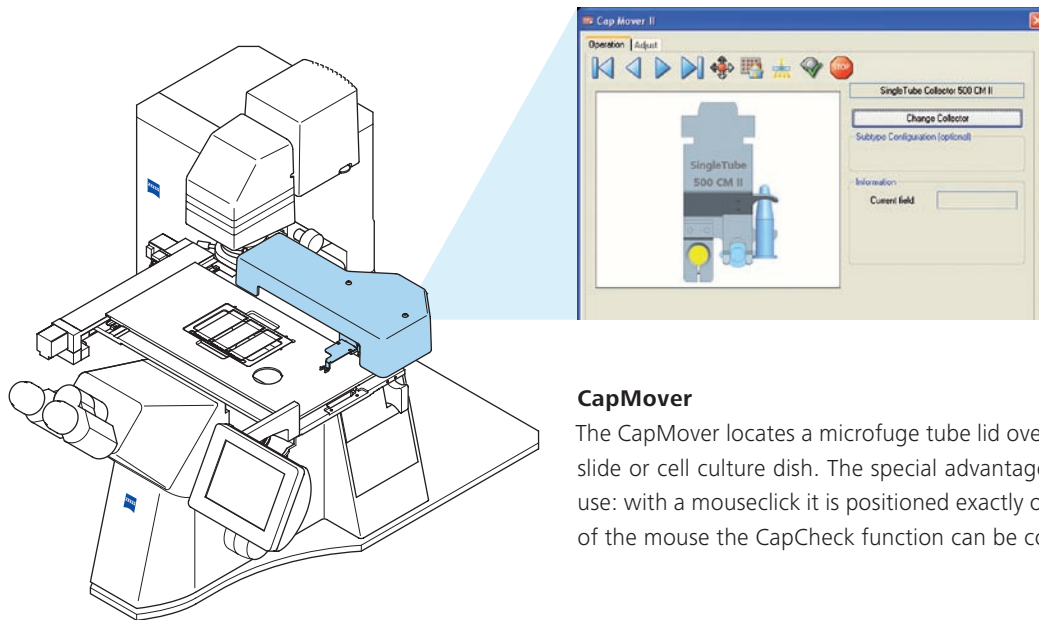

Positioning of the CapMover is made simple by the intuitive control window.

CapMover

The CapMover locates a microfuge tube lid over the capture position of a specimen slide or cell culture dish. The special advantage of the CapMover lies in its ease of use: with a mouseclick it is positioned exactly over the specimen, with another click of the mouse the CapCheck function can be conducted.

RoboMover inserts will be automatically recognized so that predefined capture sequences can be initiated from the element list.

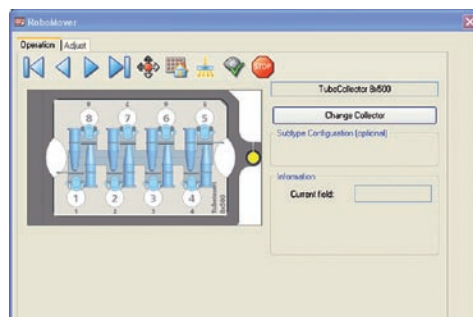

RoboMover

The RoboMover is the advanced form of the CapMover. It enables, for example, the exact division of several selected elements into different Caps or even in the recesses of a microtiter plate. The RoboMover automatically sorts the color-coded elements into the pre-set collection devices. In this manner, hundreds of samples can be precisely sorted and collected.

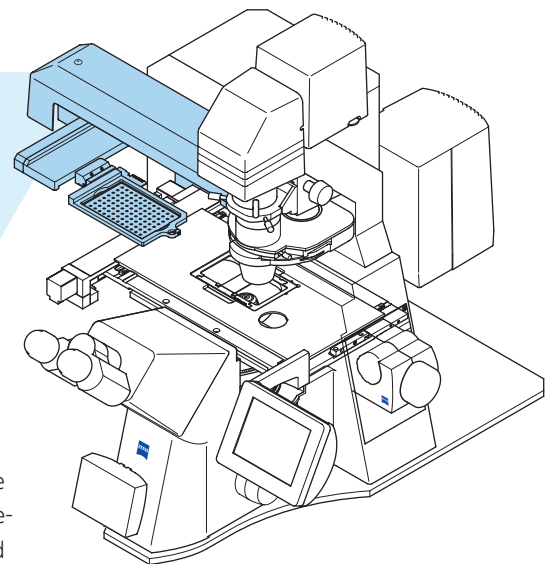

The Intuitive Interface of the PALM Systems

Software for the PALM systems is perfectly tailored to fit your individual requirements and makes microdissection and manipulation even more comfortable.

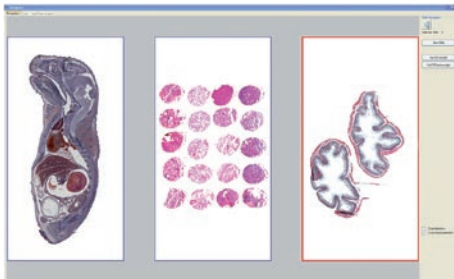

'Navigator' generates a low magnification overview for each slide enabling the user to quickly move between distant regions of one or more slides.

With 'Element list' the user can easily manage large numbers of element definitions and keep track of complex microdissection sequences.

Color	Nr	Name	Type	Laser function	Objective	Vial	Area (µm ²)	Grip	cutshot	Comment
	1		Freehand	Cut	10x - Fluor 10x/0.50 M27	(Tube 1)	30769.58			grün
	2		Freehand	Cut	10x - Fluor 10x/0.50 M27	(Tube 1)	23223.35			grün
	3		Freehand	RoboLPC	10x - Fluor 10x/0.50 M27	Tube 2	32206.22			grün
	4		Freehand	RoboLPC	53x - LD Plan/Neoku 63x/0.75 Kon...	Tube 4	30229.09			blau
	5		Freehand	RoboLPC	10x - Fluor 10x/0.50 M27	Tube 2	26929.34			grün
	6		Circle	RoboLPC	10x - Fluor 10x/0.50 M27	Tube 2	3650.14			grün
	7		Circle	RoboLPC	40x - LD Plan/Neoku 40x/0.6 Kon...	Tube 3	3705.95			rot
	8		Rectangle	RoboLPC	40x - LD Plan/Neoku 40x/0.6 Kon...	Tube 3	5571.72			rot

The intuitive user interface is clearly structured and quickly accessible. Functions such as the element list or the customizable database ensure that you have a complete overview of your experiment at all times.

The standard version of the software contains all the functions that you need for routine use. For the advanced user that needs the full range of capabilities of the systems, we recommend "Software Pro" which allows for greater customization to experimental demands.

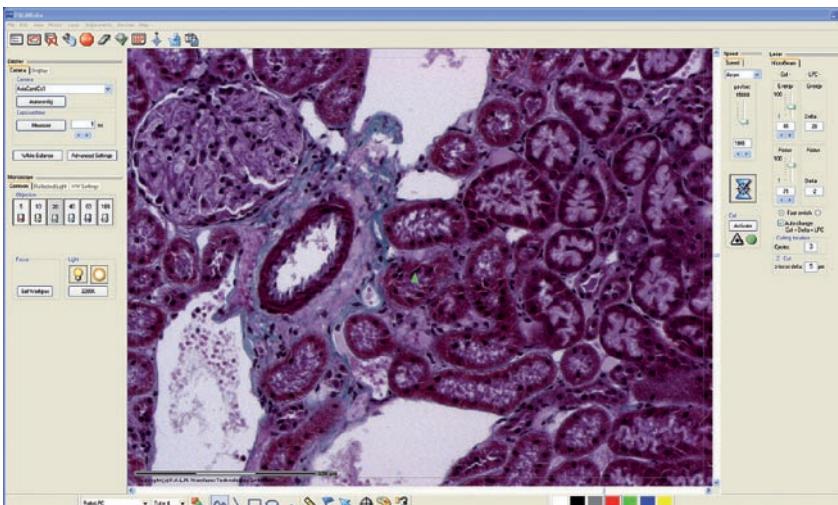

The PALM software interface puts routine system functions at your finger tips. The icon layout is designed to enhance the operation workflow of the system.

The Functions of Software:

- Intuitive user interface
- Specific laser tools, for glass as well as membrane covered slides
- Navigation over several slides and serial sections
- Optimized user management with element lists and individualized settings
- Graphic tools: freehand, circle, or square
- Integrated imaging functionality: multi-channel fluorescence and extended depth of field
- Digital camera technology
- Integrated image analysis

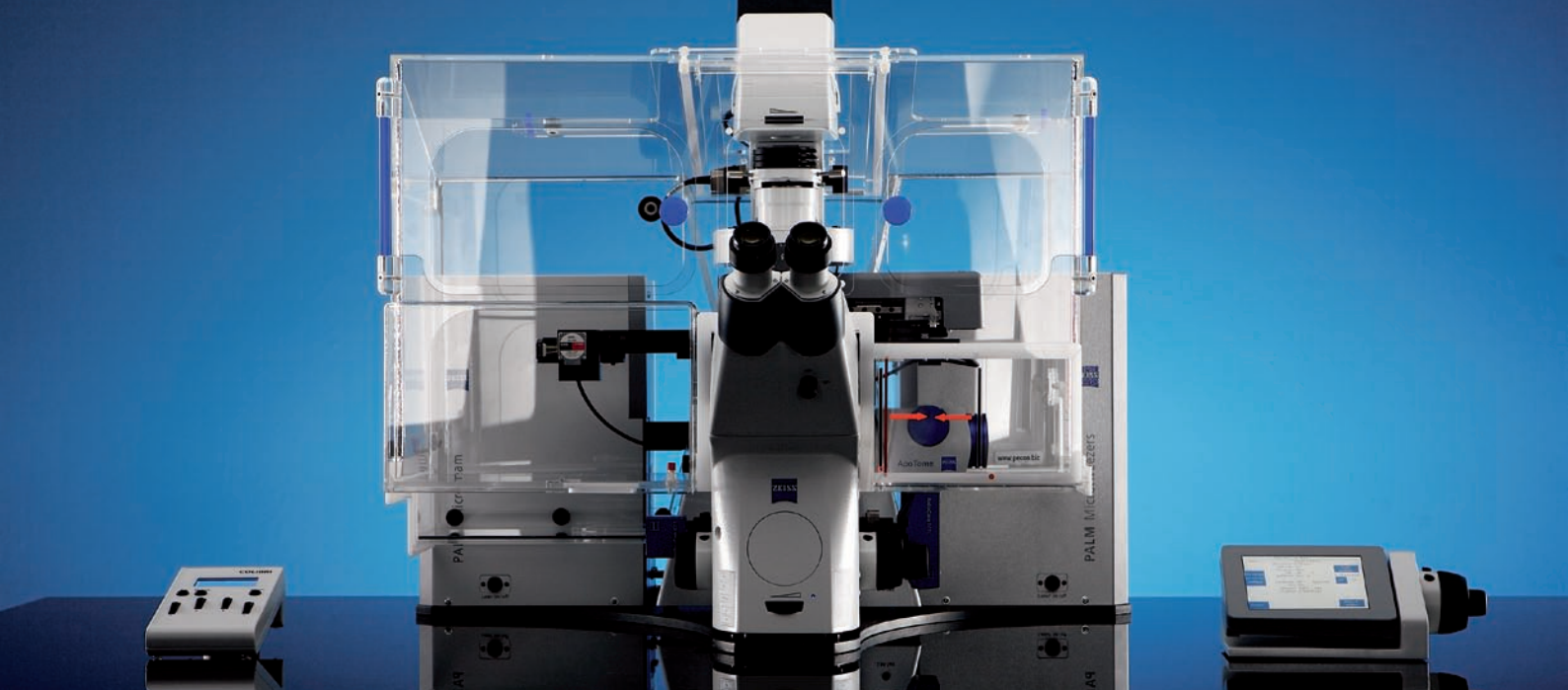

From Microdissection System to Research Platform

Incubation

The Incubator XL PALM S1 with software controlled thermostat guarantees a stable environment for living cells.

With the built-in inverted research microscope Axio Observer, the PALM systems offer not only highly specialized microdissection technology, but also the proven imaging functionality from Carl Zeiss. Furthermore PALM systems are compatible with countless other ZEISS components and allow expansion to a multi-faceted research platform.

AxioCam Series

Ranging from 1.4 to 13 megapixels, the AxioCam series has the optimal solution for all requirements in digital camera technology.



Colibri

Instead of a conventional white light source, Colibri uses high-power LEDs for contrast-rich images with high dynamic range.



ApoTome

The innovative plug-in module for the fluorescence beam path with "grid projection" for improved image quality and 3D microscopy.



Contrast Methods from Carl Zeiss

For example PlasDIC, the first polarization-optical differential interference contrast that allows the use of plastic dishes.

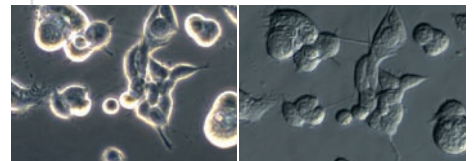

Patents

US Patents: 5.998.129, 5.689.109, 6.930.764,

Other Patents: EP 879408 B1, JP 3311757, EP 679325 B1,
DE 102 54 229.5



PALM Systems use laser devices and comply with the international safety requirements. Please mind your local safety regulations when working with lasers. For assistance ask your sales representative.

The PALM Family:

- Absolute purity in sample extraction
- Maximum preservation of the material
- Combined microdissection and high-end imaging technology
- Intuitive user interface
- Digital camera technology
- Application support and comprehensive service

**Laser Technology from Carl Zeiss:
Success Factor in Modern Science**

Carl Zeiss Microlmaging GmbH
07740 Jena, Germany

BioSciences | Microdissection | Munich Location

Phone : +49 (0) 89 90 9000 - 800

Telefax: +49 (0) 89 90 9000 - 820

E-Mail : palm-info@zeiss.de

www.zeiss.de/microdissection